



**Shear Wall
Design Manual**

Structural Use of Concrete

BS 8110-1997

For ETABS® 2016

Copyright

Copyright © Computers & Structures, Inc., 1978-2015
All rights reserved.

The CSI Logo®, SAP2000®, ETABS®, and SAFE® are registered trademarks of Computers & Structures, Inc. Watch & Learn™ is a trademark of Computers & Structures, Inc.

The computer programs SAP2000® and ETABS® and all associated documentation are proprietary and copyrighted products. Worldwide rights of ownership rest with Computers & Structures, Inc. Unlicensed use of these programs or reproduction of documentation in any form, without prior written authorization from Computers & Structures, Inc., is explicitly prohibited.

No part of this publication may be reproduced or distributed in any form or by any means, or stored in a database or retrieval system, without the prior explicit written permission of the publisher.

Further information and copies of this documentation may be obtained from:

Computers & Structures, Inc.
<http://www.csiamerica.com/>

info@csiamerica.com (for general information)
support@csiamerica.com (for technical support)

DISCLAIMER

CONSIDERABLE TIME, EFFORT AND EXPENSE HAVE GONE INTO THE DEVELOPMENT AND TESTING OF THIS SOFTWARE. HOWEVER, THE USER ACCEPTS AND UNDERSTANDS THAT NO WARRANTY IS EXPRESSED OR IMPLIED BY THE DEVELOPERS OR THE DISTRIBUTORS ON THE ACCURACY OR THE RELIABILITY OF THIS PRODUCT.

THIS PRODUCT IS A PRACTICAL AND POWERFUL TOOL FOR STRUCTURAL DESIGN. HOWEVER, THE USER MUST EXPLICITLY UNDERSTAND THE BASIC ASSUMPTIONS OF THE SOFTWARE MODELING, ANALYSIS, AND DESIGN ALGORITHMS AND COMPENSATE FOR THE ASPECTS THAT ARE NOT ADDRESSED.

THE INFORMATION PRODUCED BY THE SOFTWARE MUST BE CHECKED BY A QUALIFIED AND EXPERIENCED ENGINEER. THE ENGINEER MUST INDEPENDENTLY VERIFY THE RESULTS AND TAKE PROFESSIONAL RESPONSIBILITY FOR THE INFORMATION THAT IS USED.

Contents

1	Introduction	
1.1	Organization	1-2
1.2	Recommended Reading/Practice	1-2
2	Design Prerequisites	
2.1	Notation	2-1
2.2	Design Station Locations	2-7
2.3	Default Design Load Combinations	2-8
2.3.1	Dead Load Component	2-9
2.3.2	Live Load Component	2-9
2.3.3	Wind Load Component	2-9
2.3.4	Combinations that Include Static Nonlinear Results	2-9
2.4	Shear Wall Design Preferences	2-9
2.5	Shear Wall Design Overwrites	2-10
2.6	Choice of Units	2-10
3	Pier Design	
3.1	Wall Pier Flexural Design	3-1
3.1.1	Designing a Simplified Pier Section	3-2
3.1.2	Checking a General or Uniform Reinforcing Pier Section	3-7
3.1.3	Wall Pier Demand/Capacity Ratio	3-16

3.1.4	Designing a General Reinforcing Pier Section	3-17
3.2	Wall Pier Shear Design	3-18
3.2.1	Determine the Concrete Shear Capacity	3-19
3.2.2	Determine the Required Shear Reinforcing	3-20
4	Spandrel Design	
4.1	Spandrel Flexural Design	4-1
4.1.1	Determine the Maximum Factored Moments	4-2
4.1.2	Determine the Required Flexural Reinforcing	4-2
4.2	Spandrel Shear Design	4-9
4.2.1	Determine the Concrete Shear Capacity	4-10
4.2.2	Determine the Required Shear Reinforcing	4-11

Appendix A Shear Wall Design Preferences

Appendix B Design Procedure Overwrites

Appendix C Analysis Sections and Design Sections

Chapter 1

Introduction

The program performs the following design, check, or analysis processes:

- Design and check of concrete wall piers for flexural and axial loads
- Design of concrete wall piers for shear
- Design of concrete shear wall spandrels for flexure
- Design of concrete wall spandrels for shear

Initiation of the design process, along with control of various design parameters, is accomplished using the **Design menu**.

Automated design at the object level is available as long as the structures have first been modeled and analyzed by the program. Model and analysis data, such as material properties and member forces, are recovered directly from the model database, and no additional user input is required if the design defaults are acceptable.

The design is based on a set of user-specified loading combinations. However, the program provides default load combinations for each design code supported in the program. If the default load combinations are acceptable, no definition of additional load combinations is required.

The program supports a range of shear wall design codes, including many national building codes. This manual is dedicated to the use of the menu option "BS 8110-1997." This option covers the "*Code of Practice for Structural Use of Concrete 1987*" (BS 1997) (incorporating the Amendments No. 1, 2 and 3). The details of the shear wall design and stress check algorithms used by the program when the user selects the BS 8110-1997 design code are described in this manual.

The program provides detailed output data for Simplified pier section design, Section Designer pier section design, Section Designer pier section check, and Spandrel design.

1.1 Organization

This manual is designed to help you quickly become productive with the shear wall design options of the BS 8110-1997 code. Chapter 2 provides detailed descriptions of the Design Prerequisites used for BS 8110-1997. Chapter 3 provides detailed descriptions of the design and check of concrete wall piers for flexural and axial loads and the design of concrete wall piers for shear in accordance with the BS 8110-1997 code. Chapter 4 provides detailed descriptions of design of concrete shear wall spandrels for flexure and design of concrete wall spandrels for shear in accordance with the BS 8110-1997 code. The appendices provide details on certain topics referenced in this manual.

1.2 Recommended Reading/Practice

It is strongly recommended that you read this manual and review any applicable "Watch & Learn" Series™ tutorials, which are found on our web site, <http://www.csiberkeley.com>, before attempting to design a shear wall. Additional information can be found in the on-line Help facility available from within the program's main menu.

Chapter 2

Design Prerequisites

This chapter identifies the various notations used in this manual. The default load combinations when the user selects the BS 8110-1997 design code are described. Additionally, preferences and overwrites are introduced, and units applied when the user selects the BS 8110-1997 design code also are identified.

The design is based on loading combinations specified by the user. To facilitate the design process, the program provides a set of default load combinations that should satisfy requirements for the design of most building type structures.

2.1 Notation

Following are the notations used in this manual.

A_{cv} Net area of a wall pier bounded by the length of the wall pier, L_p , and the web thickness, t_p , mm^2

A_g Gross area of a wall pier, mm^2

A_{h-min}	Minimum required area of distributed horizontal reinforcing steel required for shear in a wall spandrel, mm^2 / mm
A_s	Area of reinforcing steel, mm^2
A_{sc}	Area of reinforcing steel required for compression in a pier edge member, or the required area of tension steel required to balance the compression steel force in a wall spandrel, mm^2
A_{sc-max}	Maximum area of compression reinforcing steel in a wall pier edge member, mm^2
A_{sf}	The required area of tension reinforcing steel for balancing the concrete compression force in the extruding portion of the concrete flange of a T-beam, mm^2
A_{st}	Area of reinforcing steel required for tension in a pier edge member, mm^2
A_{st-max}	Maximum area of tension reinforcing steel in a wall pier edge member, mm^2
A_{sv}	Area of reinforcing steel required for shear, mm^2 / mm
A_{vd}	Area of diagonal shear reinforcement in a coupling beam, mm^2
A_{v-min}	Minimum required area of distributed vertical reinforcing steel required for shear in a wall spandrel, mm^2 / mm
A_{sw}	The required area of tension reinforcing steel for balancing the concrete compression force in a rectangular concrete beam, or for balancing the concrete compression force in the concrete web of a T-beam, mm^2
A'_s	Area of compression reinforcing steel in a spandrel, mm^2
$B_1, B_2...$	Length of a concrete edge member in a wall with uniform thickness, mm
C_c	Concrete compression force in a wall pier or spandrel, N

C_f	Concrete compression force in the extruding portion of a T-beam flange, N
C_s	Compression force in wall pier or spandrel reinforcing steel, N
C_w	Concrete compression force in the web of a T-beam, N
D/C	Demand/Capacity ratio as measured on an interaction curve for a wall pier, unitless
$DB1$	Length of a user-defined wall pier edge member, mm. This can be different on the left and right sides of the pier, and it also can be different at the top and the bottom of the pier.
$DB2$	Width of a user-defined wall pier edge member, mm. This can be different on the left and right sides of the pier, and it also can be different at the top and the bottom of the pier.
E_s	Modulus of elasticity of reinforcing steel, MPa.
$IP\text{-max}$	The maximum ratio of reinforcing considered in the design of a pier with a Section Designer section, unitless
$IP\text{-min}$	The minimum ratio of reinforcing considered in the design of a pier with a Section Designer section, unitless
L_{BZ}	Horizontal length of the boundary zone at each end of a wall pier, mm
L_p	Horizontal length of wall pier, mm. This can be different at the top and the bottom of the pier
L_s	Horizontal length of wall spandrel, mm
Q_k	Live load
M	Factored bending moment at a design section, N-mm
M_c	In a wall spandrel with compression reinforcing, the factored bending moment at a design section resisted by the couple between the concrete in compression and the tension steel, N-mm

M_f	In a wall spandrel with a T-beam section and compression reinforcing, the factored bending moment at a design section resisted by the couple between the concrete in compression in the extruding portion of the flange and the tension steel, N-mm
M_s	In a wall spandrel with compression reinforcing, the factored bending moment at a design section resisted by the couple between the compression steel and the tension steel, N-mm
M_w	In a wall spandrel with a T-beam section and compression reinforcing, the factored bending moment at a design section resisted by the couple between the concrete in compression in the web and the tension steel, N-mm
OC	On a wall pier interaction curve the "distance" from the origin to the capacity associated with the point considered
OL	On a wall pier interaction curve the "distance" from the origin to the point considered
N_b	The axial force in a wall pier at a balanced strain condition, N
N_{left}	Equivalent axial force in the left edge member of a wall pier used for design, N. This may be different at the top and the bottom of the wall pier.
N_{max}	Limit on the maximum compressive design strength specified by BS 8110-1997, N.
N_r	Nominal axial strength, N.
N_o	Nominal axial load strength of a wall pier, N.
$N_{r,max}$	The maximum compression force a wall pier can carry with strength reduction factors set equal to one, N.
$N_{t,max}$	The maximum tension force a wall pier can carry with strength reduction factors set equal to one, N.

N_{right}	Equivalent axial force in the right edge member of a wall pier used for design, N. This may be different at the top and the bottom of the wall pier.
N	Factored axial force at a design section, N.
NC_{max}	Maximum ratio of compression steel in an edge member of a wall pier, unitless
NT_{max}	Maximum ratio of tension steel in an edge member of a wall pier, unitless
R_{LW}	Shear strength reduction factor as specified in the concrete material properties, unitless. This reduction factor applies to lightweight concrete. It is equal to 1 for normal weight concrete.
RLL	Reduced live load
N_s	Tension force in wall pier reinforcing steel, N.
V_c	The portion of the shear force carried by the concrete, N.
V_r	Design shear strength, N.
V_s	The portion of the shear force in a spandrel carried by the shear reinforcing steel, N.
V	Factored shear force at a design section, N.
W_k	Wind load
a	Depth of the wall pier or spandrel compression block, mm
a_l	Depth of the compression block in the web of a T-beam, mm
b_s	Width of the compression flange in a T-beam, mm. This can be different on the left and right ends of the T-beam.
c	Distance from the extreme compression fiber of the wall pier or spandrel to the neutral axis, mm

d_{r-bot}	Distance from bottom of spandrel beam to centroid of the bottom reinforcing steel, mm. This can be different on the left and right ends of the beam.
d_{r-top}	Distance from top of spandrel beam to centroid of the top reinforcing steel, mm. This can be different on the left and right ends of the beam.
d_s	Depth of the compression flange in a T-beam, mm. This can be different on the left and right ends of the T-beam.
$d_{spandrel}$	Depth of spandrel beam minus cover to centroid of reinforcing, mm
f_y	Yield strength of steel reinforcing, N/mm ² . This value is used for flexural and axial design calculations.
f_{ys}	Yield strength of steel reinforcing, N/mm ² . This value is used for shear design calculations.
f'_{cu}	Concrete compressive strength, N/mm ² . This value is used for flexural and axial design calculations.
f'_{cs}	Concrete compressive strength, N/mm ² . This value is used for shear design calculations.
f'_s	Stress in compression steel of a wall spandrel, N/mm ² .
h_s	Height of a wall spandrel, mm. This can be different on the left and right ends of the spandrel.
k_1	Shear strength enhancement factor.
k_2	Concrete shear strength factor. $[f_{cu}/25]^{1/3}$
p_{max}	Maximum ratio of reinforcing steel in a wall pier with a Section Designer section that is designed (not checked), unitless.
p_{min}	Minimum ratio of reinforcing steel in a wall pier with a Section Designer section that is designed (not checked), unitless.

t_p	Thickness of a wall pier, mm. This can be different at the top and bottom of the pier.
t_s	Thickness of a wall spandrel, mm. This can be different on the left and right ends of the spandrel.
ΣG_k	The sum of all dead load cases
ΣQ_k	The sum of all live load cases
ΣRQ_k	The sum of all reduced live load cases
x	Neutral axis depth, mm
x_{bal}	Depth of neutral axis in balanced condition, mm
z	Lever arm, mm
ϵ	Reinforcing steel strain, unitless
ϵ_c	Maximum allowed compression strain in concrete, 0.0035.
ϵ_s	Reinforcing steel strain in a wall pier, unitless
ϵ'_s	Compression steel strain in a wall spandrel, unitless
γ_m	Partial safety factor for strength of materials (BS 2.4.4.1).
	$\gamma_m = \begin{cases} 1.15, & \text{for reinforcement,} \\ 1.50, & \text{for concrete in flexure and axial load, and} \\ 1.25, & \text{for shear strength without shear reinforcement.} \end{cases}$

2.2 Design Station Locations

The program designs wall piers at stations located at the top and bottom of the pier only. To design at the mid-height of a pier, break the pier into two separate "half-height" piers.

The program designs wall spandrels at stations located at the left and right ends of the spandrel only. To design at the mid-length of a spandrel, break

the spandrel into two separate "half-length" piers. Note that if a spandrel is broken into pieces, the program will calculate the seismic diagonal shear reinforcing separately for each piece. The angle used to calculate the seismic diagonal shear reinforcing for each piece is based on the length of the piece, not the length of the entire spandrel.

2.3 Default Design Load Combinations

The design load combinations automatically created by the program for concrete shear wall design are given by Equations 1 through 8 (BS 2.4.3).

$$1.4\Sigma G_k \quad \text{Eqn. 1}$$

$$1.4\Sigma G_k + 1.6(\Sigma Q_k + \Sigma RQ_k) \quad \text{Eqn. 2}$$

$$1.2\Sigma G_k + 1.2(\Sigma Q_k + \Sigma RQ_k) + 1.2W_k \quad \text{Eqn. 3}$$

$$1.2\Sigma G_k + 1.2(\Sigma Q_k + \Sigma RQ_k) - 1.2W_k \quad \text{Eqn. 4}$$

$$1.4\Sigma G_k + 1.4W_k \quad \text{Eqn. 5}$$

$$1.4\Sigma G_k - 1.4W_k \quad \text{Eqn. 6}$$

$$1.0\Sigma G_k + 1.4W_k \quad \text{Eqn. 7}$$

$$1.0\Sigma G_k - 1.4W_k \quad \text{Eqn. 8}$$

In Equations 1 through 8,

ΣG_k = The sum of all dead load (DL) load cases defined for the model.

ΣQ_k = The sum of all live load (LL) load cases defined for the model.
Note that this includes roof live loads as well as floor live loads.

ΣRQ_k = The sum of all reducible live load (RLL) load cases defined for the model.

W_k = Any single wind load (WL) load case defined for the model.

2.3.1 Dead Load Component

The dead load component of the default design load combinations consists of the sum of all dead loads multiplied by the specified factor. Individual dead load cases are not considered separately in the default design load combinations.

2.3.2 Live Load Component

The live load component of the default design load combinations consists of the sum of all live loads, both reducible and nonreducible, multiplied by the specified factor. Individual live load cases are not considered separately in the default design load combinations.

2.3.3 Wind Load Component

The wind load component of the default design load combinations consists of the contribution from a single wind load case. Thus, if multiple wind load cases are defined in the program model, each of Equations 3 through 8 will contribute multiple design load combinations, one for each wind load case that is defined.

2.3.4 Combinations That Include Static Nonlinear Results

The default shear wall design load combinations do not include any static nonlinear results. To include static nonlinear results in a design load combination, define the load combination yourself.

If a design load combination includes a single static nonlinear case and nothing else, the design is performed for each step of the static nonlinear analysis. Otherwise, the design is performed for the last step of the static nonlinear analysis only.

2.4 Shear Wall Design Preferences

The shear wall design preferences are basic properties that apply to all wall pier and spandrel elements. Appendix A identifies shear wall design preferences for BS 8110-1997.

Default values are provided for all shear wall design preference items. Thus, it is not required that preferences be specified. However, at least review the default values for the preference items to make sure they are acceptable.

2.5 Shear Wall Design Overwrites

The shear wall design overwrites are basic assignments that apply only to those piers or spandrels to which they are assigned. The overwrites for piers and spandrels are separate. Appendix B identifies the shear wall overwrites for BS 8110-1997. Note that the available overwrites change depending on the pier section type (Uniform Reinforcing, General Reinforcing, or Simplified T and C).

Default values are provided for all pier and spandrel overwrite items. Thus, it is not necessary to specify or change any of the overwrites. However, at least review the default values for the overwrite items to make sure they are acceptable. When changes are made to overwrite items, the program applies the changes only to the elements to which they are specifically assigned; that is, to the elements that are selected when the overwrites are changed.

2.6 Choice of Units

For shear wall design in this program, any set of consistent units can be used for input. Also, the system of units being used can be changed at any time. Typically, design codes are based on one specific set of units.

The BS 8110-1997 code is based on Newton-millimeter-Second units. For simplicity, all equations and descriptions presented in this manual correspond to **Newton-millimeter-second** units unless otherwise noted.

The shear wall design preferences allow the user to specify special units for concentrated and distributed areas of reinforcing. These units are then used for reinforcing in the model, regardless of the current model units displayed in the drop-down list on the status bar (or within a specific form). The special units specified for concentrated and distributed areas of reinforcing can only be changed in the shear wall design preferences.

The choices available in the shear wall design preferences for the units associated with an area of concentrated reinforcing are in^2 , cm^2 , mm^2 , and current units. The choices available for the units associated with an area per unit length of distributed reinforcing are in^2/ft , cm^2/m , mm^2/m , and current units.

The current units option uses whatever units are currently displayed in the drop-down list on the status bar (or within a specific form). If the current length units are m, this option means concentrated areas of reinforcing are in m^2 and distributed areas of reinforcing are in m^2/m . Note that when using the "current" option, areas of distributed reinforcing are specified in $\text{Length}^2/\text{Length}$ units, where Length is the currently active length unit. For example, if you are working in kN and m units, the area of distributed reinforcing is specified in m^2/m . If you are in kN and mm, the area of distributed reinforcing is specified in m^2/mm .

Chapter 3 Pier Design

This chapter describes how the program designs each leg of concrete wall piers for shear using BS 8110-1997. Reference to the BS 8110-1997 code in this chapter is identified with the prefix “**BS.**” Note that in this program shear reinforcing cannot be specified and then be checked by the program. The program only designs the pier for shear and reports how much shear reinforcing is required. The shear design is performed at stations at the top and bottom of the pier.

This chapter also describes how the program designs and checks concrete wall piers for flexural and axial loads using BS 8110-1997. First we describe how the program *designs* piers that are specified by a simplified section. Next we describe how the program *checks* piers that are specified using the Section Designer utility. Then we describe how the program *designs* piers that are specified using the Section Designer utility.

3.1 Wall Pier Flexural Design

For both designing and checking piers, it is important to understand the local axis definition for the pier. Access the local axes assignments using the **Assign menu**.

3.1.1 Designing a Simplified Pier Section

This section describes how the program designs a pier that is assigned a simplified section. The geometry associated with the simplified section is illustrated in Figure 3-1. The pier geometry is defined by a length, thickness and size of the edge members at each end of the pier (if any).

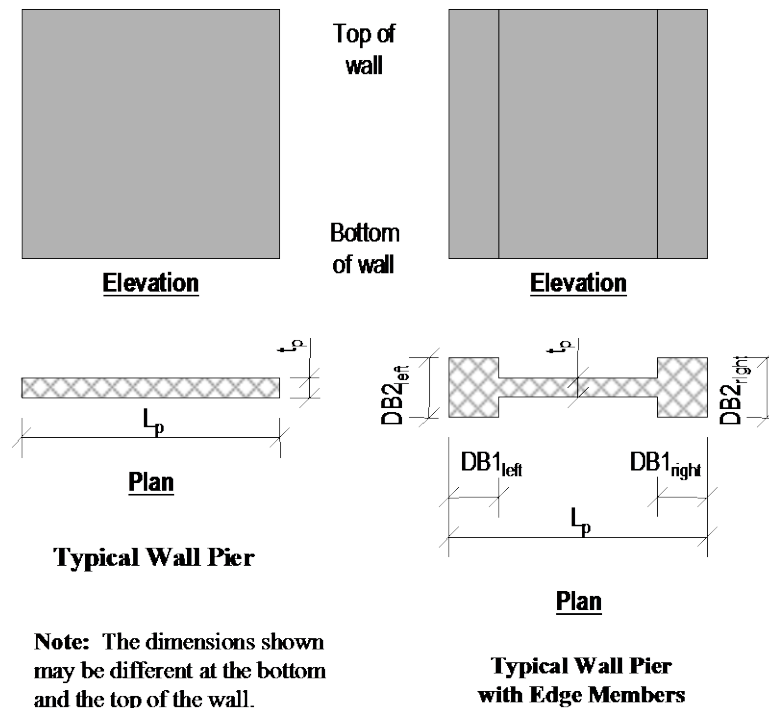

Figure 3-1: Typical Wall Pier Dimensions Used for Simplified Design

A simplified T and C pier section is always planar (not three-dimensional). The dimensions shown in the figure include the following:

- The length of the wall pier is designated L_p . This is the horizontal length of the wall pier in plan.
- The thickness of the wall pier is designated t_p . The thickness specified for left and right edge members ($DB2_{left}$ and $DB2_{right}$) may be different from this wall thickness.

- DB1 represents the horizontal length of the pier edge member. DB1 can be different at the left and right sides of the pier.
- DB2 represents the horizontal width (or thickness) of the pier edge member. DB2 can be different at the left and right sides of the pier.

The dimensions illustrated are specified in the shear wall overwrites (Appendix B) and can be specified differently at the top and bottom of the wall pier.

If no specific edge member dimensions have been specified by the user, the program assumes that the edge member is the same width as the wall, and the program determines the required length of the edge member. In all cases, whether the edge member size is user-specified or program-determined, the program reports the required area of reinforcing steel at the center of the edge member. This section describes how the program-determined length of the edge member is determined and how the program calculates the required reinforcing at the center of the edge member.

Three design conditions are possible for a simplified wall pier. These conditions are illustrated in Figure 3-2.



Design Condition 1
Wall pier with uniform thickness and ETABS-determined (variable length) edge members

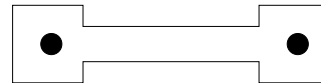

Design Condition 2
Wall pier with user-defined edge members

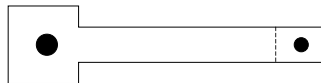

Design Condition 3
Wall pier with a user-defined edge member on one end and an ETABS-determined (variable length) edge member on the other end

Note:
In all three conditions, the only reinforcing designed by ETABS is that required at the center of the edge members

Figure 3-2: Design Conditions for Simplified Wall Piers

- The wall pier has program-determined (variable length and fixed width) edge members on each end.
- The wall pier has user-defined (fixed length and width) edge members on each end.
- The wall pier has a program-determined (variable length and fixed width) edge member on one end and a user-defined (fixed length and width) edge member on the other end.

3.1.1.1 Design Condition 1

Design condition 1 applies to a wall pier with uniform design thickness and program-determined edge member length. For this design condition, the design algorithm focuses on determining the required size (length) of the edge members, while limiting the compression and tension reinforcing located at the center of the edge members to user-specified maximum ratios. The maximum ratios are specified in the shear wall design preferences and the pier design overwrites as Edge Design NC-Max and Edge Design NT-Max.

Consider the wall pier shown in Figure 3-3. For a given design section, say the top of the wall pier, the wall pier for a given design load combination is designed for a factored axial force N_{-top} and a factored moment M_{-top} .

The program initiates the design procedure by assuming an edge member at the left end of the wall with a thickness t_p and width B_{1-left} , and an edge member at the right end of the wall with a thickness t_p and width $B_{1-right}$. Initially $B_{1-left} = B_{1-right} = t_p$.

The moment and axial force are converted to an equivalent force set $N_{left-top}$ and $N_{right-top}$ using the relationships shown in the following equations. (Similar equations apply at the bottom of the pier.)

$$N_{left-top} = \frac{N_{-top}}{2} + \frac{M_{-top}}{(L_p - 0.5B_{1-left} - 0.5B_{1-right})}$$

$$N_{right-top} = \frac{N_{-top}}{2} - \frac{M_{-top}}{(L_p - 0.5B_{1-left} - 0.5B_{1-right})}$$

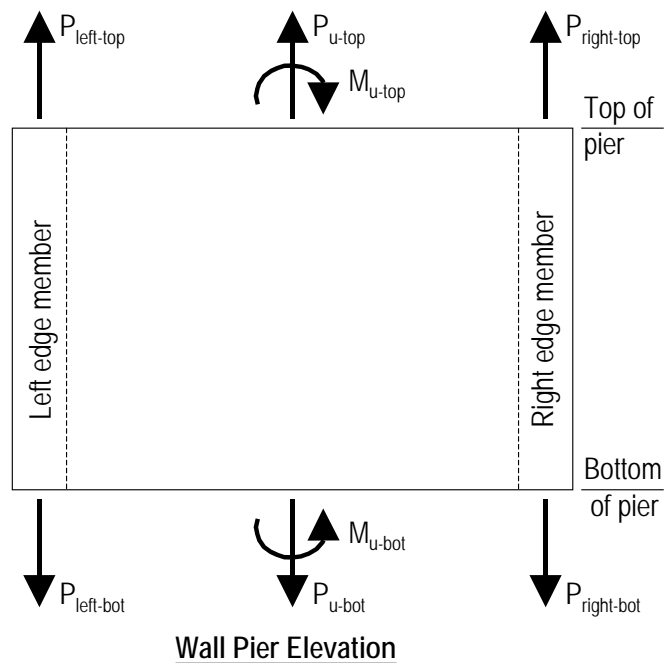
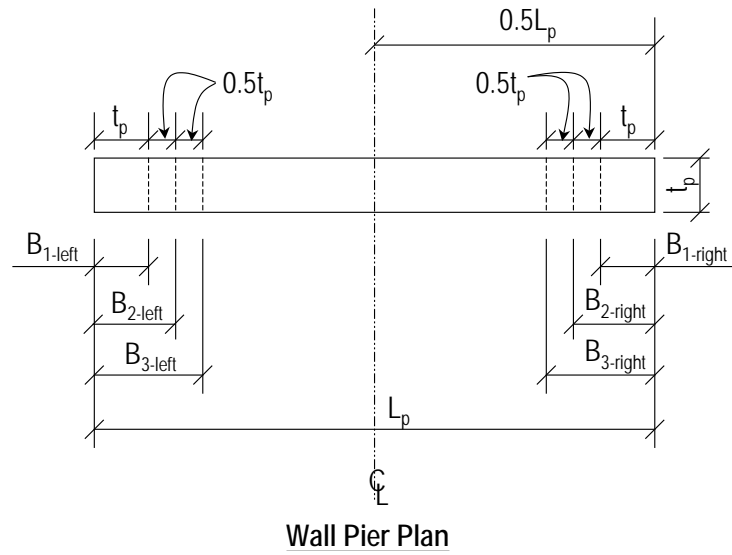

Figure 3-3: Wall Pier for Design Condition 1

For any given loading combination, the net values for set $N_{\text{left-top}}$ and $N_{\text{right-top}}$ could be tension or compression.

Note that for dynamic loads, set $N_{\text{left-top}}$ and $N_{\text{right-top}}$ are obtained at the modal level and the modal combinations are made, before combining with other loads. Also for design loading combinations involving SRSS, the set $N_{\text{left-top}}$ and $N_{\text{right-top}}$ forces are obtained first for each load case before the combinations are made.

If any value of $N_{\text{left-top}}$ or $N_{\text{right-top}}$ is tension, the area of steel required for tension, A_{st} , is calculated as:

$$A_{st} = \frac{N}{f_y / \gamma_s} \quad (\text{BS 3.4.4.1})$$

If any value of $N_{\text{left-top}}$ or $N_{\text{right-top}}$ is compression, for section adequacy, the area of steel required for compression, A_{sc} , must satisfy the following relationship.

$$Abs(N) = \left[0.67 \frac{f_{cu}}{\gamma_c} (A_g - A_{sc}) + \frac{f_y}{\gamma_s} A_{sc} \right] \quad (\text{BS 3.4.4.1})$$

where N is either $N_{\text{left-top}}$ or $N_{\text{right-top}}$, $A_g = t_p B_l$ and the P_{max} Factor is defined in the shear wall design preferences (the default is 1.0). In general, we recommend that you use the default value.

$$A_{sc} = \frac{Abs(N) - 0.67 \frac{f_{cu}}{\gamma_c} A_g}{\frac{f_y}{\gamma_s} - 0.67 \frac{f_{cu}}{\gamma_c}}$$

If A_{sc} calculates as negative, no compression reinforcing is needed.

The maximum tensile reinforcing to be packed within the t_p times B_l concrete edge member is limited by:

$$A_{st-\text{max}} = NT_{\text{max}} t_p B_l.$$

Similarly, the compression reinforcing is limited by:

$$A_{sc-\text{max}} = NC_{\text{max}} t_p B_l.$$

If A_{st} is less than or equal to $A_{st-\text{max}}$ and A_{sc} is less than or equal to $A_{sc-\text{max}}$, the program will proceed to check the next loading combination; otherwise the program will increment the appropriate B_l dimension (left, right or both, depending on which edge member is inadequate) by one-half of the wall

thickness to B_2 (i.e., $1.5t_p$) and calculate new values for $N_{\text{left-top}}$ and $N_{\text{right-top}}$ resulting in new values of A_{st} and A_{sc} . This iterative procedure continues until A_{st} and A_{sc} are within the allowed steel ratios for all design load combinations.

If the value of the width of the edge member B increments to where it reaches a value larger than or equal to $L_p/2$, the iteration is terminated and a failure condition is reported.

This design algorithm is an approximate but convenient algorithm. Wall piers that are declared overstressed using this algorithm could be found to be adequate if the reinforcing steel is user-specified and the wall pier is accurately evaluated using interaction diagrams.

3.1.1.2 Design Condition 2

Design condition 2 applies to a wall pier with user-specified edge members at each end of the pier. The size of the edge members is assumed to be fixed; that is, the program does not modify them. For this design condition, the design algorithm determines the area of steel required in the center edge members and checks if that area gives reinforcing ratios less than the user-specified maximum ratios. The design algorithm used is the same as described for condition 1; however, no iteration is required.

3.1.1.3 Design Condition 3

Design condition 3 applies to a wall pier with a user-specified (fixed dimension) edge member at one end of the pier and a variable length (program-determined) edge member at the other end. The width of the variable length edge member is equal to the width of the wall.

The design is similar to that which previously has been described for design conditions 1 and 2. The size of the user-specified edge member is not changed. Iteration occurs on the size of the variable length edge member only.

3.1.2 Checking a General or Uniform Reinforcing Pier Section

When a General Reinforcing or Uniform Reinforcing pier section is specified to be checked, the program creates an interaction surface for that pier and uses that interaction surface to determine the critical flexural demand/capacity ratio for the pier. This section describes how the program generates the interaction

surface for the pier and how it determines the demand/capacity ratio for a given design load combination.

Note: In this program, the interaction surface is defined by a series of NMM interaction curves that are equally spaced around a 360-degree circle.

3.1.2.1 Interaction Surface

In this program, a three-dimensional interaction surface is defined with reference to the N , M_2 and M_3 axes. The surface is developed using a series of interaction curves that are created by rotating the direction of the pier neutral axis in equally spaced increments around a 360 degree circle. For example, if 24 PMM curves are specified (the default), there is one curve every 15 degrees ($360^\circ/24 \text{ curves} = 15^\circ$). Figure 3-4 illustrates the assumed orientation of the pier neutral axis and the associated sides of the neutral axis where the section is in tension (designated T in the figure) or compression (designated C in the figure) for various angles.

Note that the orientation of the neutral axis is the same for an angle of θ and $\theta + 180^\circ$. The side of the neutral axis where the section is in tension or compression is the only side that changes. We recommend use of 24 interaction curves (or more) to define a three-dimensional interaction surface.

Each NMM interaction curve that makes up the interaction surface is numerically described by a series of discrete points connected by straight lines. The coordinates of those points are determined by rotating a plane of linear strain about the neutral axis on the section of the pier. Details of this process are described later in the section entitled "Details of the Strain Compatibility Analysis."

By default, 11 points are used to define a NMM interaction curve. This number can be changed in the preferences; any odd number of points greater than or equal to 11 can be specified, to be used in creating the interaction curve. If an even number is specified for this item in the preferences, the program will increment up to the next higher odd number.

Note that when creating an interaction surface for a two-dimensional wall pier, the program considers only two interaction curves—the 0° curve and the 180° curve—regardless of the number of curves specified in the preferences. Furthermore, only moments about the M_3 axis are considered for two-dimensional walls.

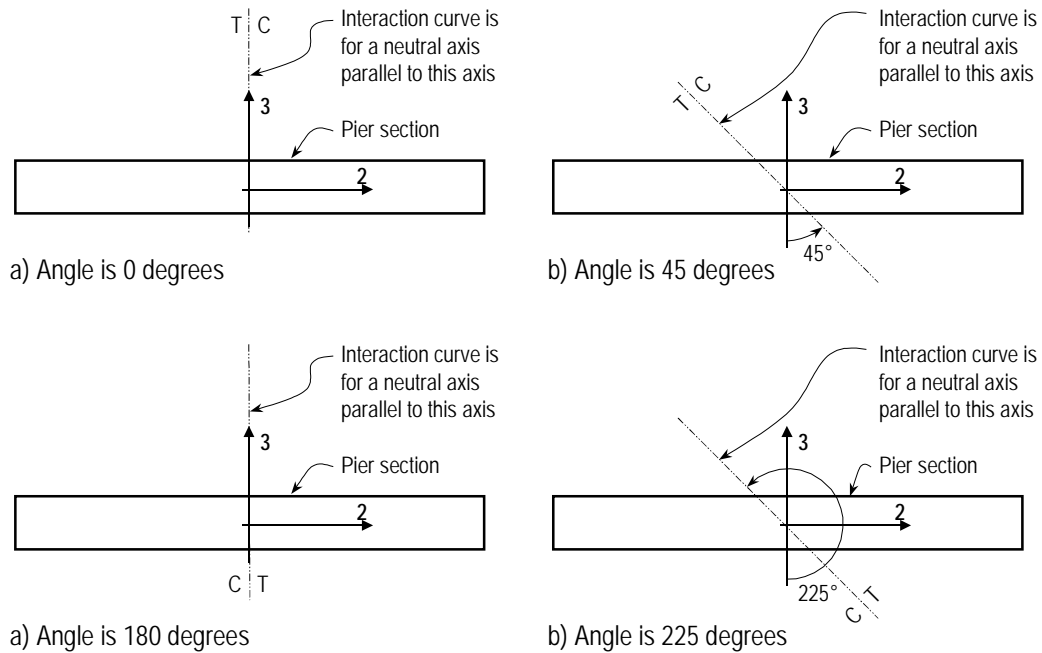

Figure 3-4: Orientation of the Pier Neutral Axis for Various Angles

3.1.2.2 Formulation of the Interaction Surface

The formulation of the interaction surface in this program is based consistently on the basic principles of ultimate strength design given in Sections 6.2.1.4 of BS 8110-1997. The program uses the requirements of force equilibrium and strain compatibility to determine the design axial load and moment strength (N_r, M_{2r}, M_{3r}) of the wall pier. For the pier to be deemed adequate, the required strength (N, M_2, M_3) must be less than or equal to the design strength, as indicated in the following equation.

$$(N, M_2, M_3) \leq (N_r, M_{2r}, M_{3r})$$

The effects of the partial safety factors for concrete ($\gamma_c = 1.50$) and for steel ($\gamma_s = 1.15$) are included in the generation of the interaction curve (BS 1.4, BS 2.4.4.1, Table 2.2)

γ_c = Partial safety factor for concrete. The value is taken as 1.5 (BS 2.4.4.1, Table 2.2).

γ_s = Partial safety factor for reinforcing steel. The value is taken as 1.15 (BS 2.4.4.1, Table 2.2).

The theoretical maximum compressive force that the wall pier can carry is designated $N_{r,max}$ and is given as follows:

$$N_{r,max} = [0.67(f_{cu}/\gamma_c)(A_g - A_s) + f_y/\gamma_s A_s] \quad (\text{BS 3.4.4.1})$$

The theoretical maximum tension force that the wall pier can carry is designated $N_{t,max}$ and is given by:

$$N_{t,max} = (f_y/\gamma_s)A_s \quad (\text{BS 3.4.4.1})$$

If the wall pier geometry and reinforcing is symmetrical in plan, the moments associated with both $N_{r,max}$ and $N_{t,max}$ are zero. Otherwise, a moment associated will be with both $N_{r,max}$ and $N_{t,max}$.

In addition to $N_{r,max}$ and $N_{t,max}$, the axial load at the balanced strain condition, i.e., N_b , is also determined. In this condition, the tension reinforcing reaches the strain corresponding to its specified yield strength modified by a corresponding partial factor of safety, f_y/γ_{ms} , as the concrete reaches its assumed ultimate strain.

Note: The number of points to be used in creating interaction diagrams can be specified in the shear wall preferences and overwrites.

As previously mentioned, by default, 11 points are used to define a single interaction curve. When creating a single interaction curve, the program includes the points at N_b , N_{oc} and N_{ot} on the interaction curve. Half of the remaining number of specified points on the interaction curve occur between N_b and N_{oc} at approximately equal spacing along the N axis. The other half of the remaining number of specified points on the interaction curve occur between N_b and N_{ot} at approximately equal spacing along the N axis.

Figure 3-7 shows a plan view of an example two-dimensional wall pier. Notice that the concrete is symmetrical but the reinforcing is not symmetrical in this example.

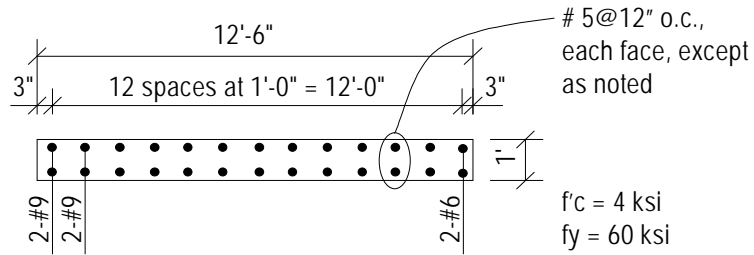

Figure 3-7: Example Two-Dimensional Wall Pier With Unsymmetrical Reinforcing

Figure 3-8 shows several interaction surfaces for the wall pier illustrated in Figure 3-7.

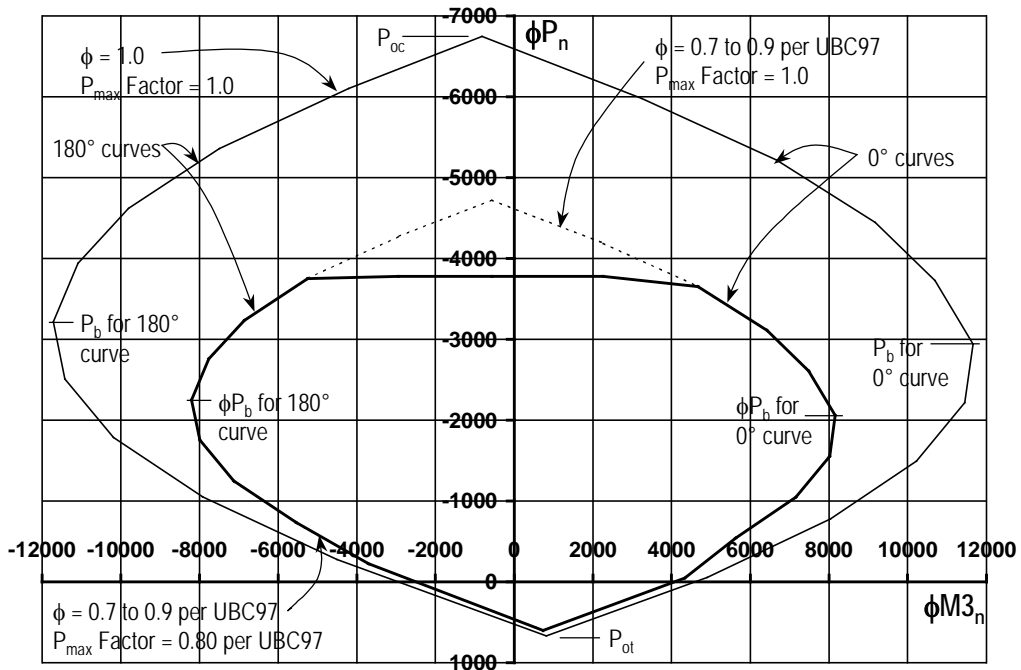

Figure 3-8 : Interaction Curves for Example Wall Pier Shown in Figure 3-7

Note the following about Figure 3-8:

- Because the pier is two-dimensional, the interaction surface consists of two interaction curves. One curve is at 0° and the other is at 180° . Only M_3 moments are considered because this is a two-dimensional example.

- In this program, compression is negative and tension is positive.
- The 0° and 180° interaction curves are not symmetric because the wall pier reinforcing is not symmetric.
- The interaction surfaces shown are created using the default value of 11 points for each interaction curve.

Figure 3-9 shows the 0° interaction curves for the wall pier illustrated in Figure 3-7. Additional interaction curves are also added to Figure 3-9.

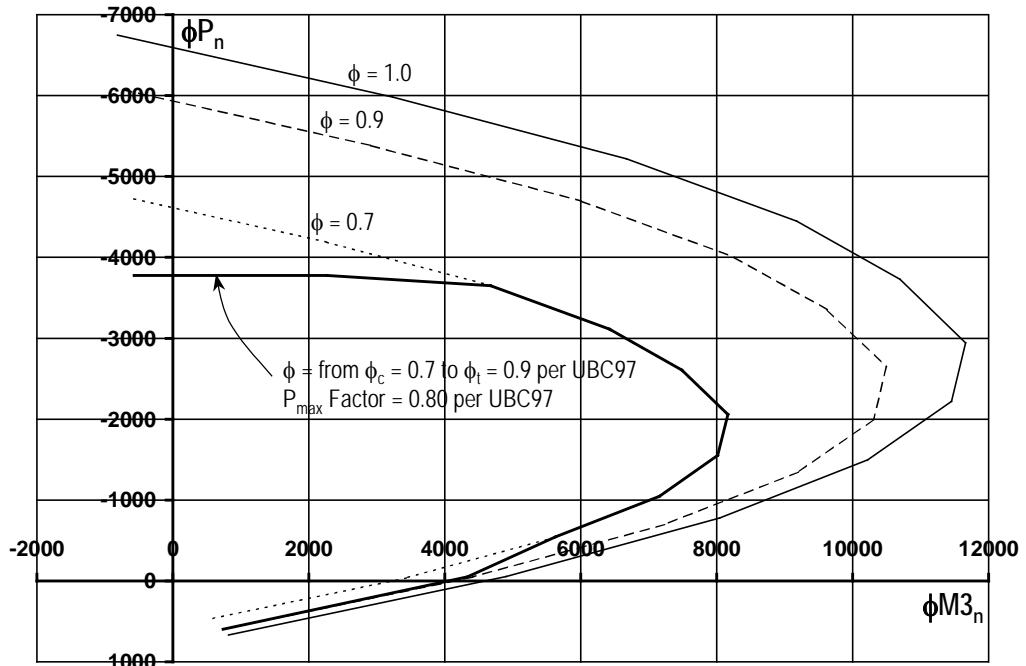

Figure 3-9: Interaction Curves for Example Wall Pier Shown in Figure 3-7

3.1.2.3 Details of the Strain Compatibility Analysis

As previously mentioned, the program uses the requirements of force equilibrium and strain compatibility to determine the factored axial load and moment strength (N , M_2 , M_3) of the wall pier. The coordinates of these points are determined by rotating a plane of linear strain on the section of the wall pier.

Figure 3-10 illustrates varying planes of linear strain such as those that the program considers on a wall pier section for a neutral axis orientation angle of 0 degrees.

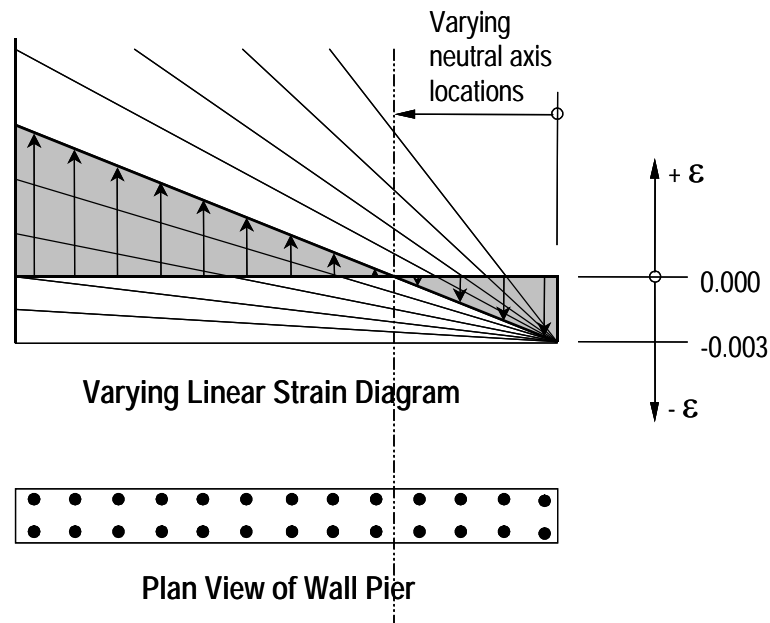

Figure 3-10: Varying Planes of Linear Strain

The linear strain diagram limits the maximum concrete strain, at the extremity of the section, to $\epsilon_{c,\max}$ (BS 3.4.4.1) as shown by the following:

$$\epsilon_c = 0.0035 \quad (\text{BS 3.4.4.1})$$

In these planes, the maximum concrete strain is always taken as $\epsilon_{c,\max}$ (BS 3.4.4.1), and the maximum steel strain is varied from $\epsilon_{c,\max}$ to plus infinity.

Recall that in this program compression is negative and tension is positive.

When the steel strain is $\epsilon_{c,\max}$, the maximum compressive force in the wall pier, N_{oc} , is obtained from the strain compatibility analysis. When the steel strain is plus infinity, the maximum tensile force in the wall pier, N_{ot} , is obtained. When the maximum steel strain is equal to the yield strain for the reinforcing, N_b is obtained.

Figure 3-11 illustrates the concrete wall pier stress-strain relationship that is obtained from a strain compatibility analysis of a typical plane of linear strain shown in Figure 3-10. In Figure 3-11 the compressive stress in the concrete, C_c , is calculated using the following equation.

$$C_c = 0.67 \frac{f_{cu}}{\gamma_c} at_p \quad (\text{BS 3.4.4.1, Figure 3.3})$$

the depth of compression block, a , is given by:

$$a = 0.9x \quad (\text{BS 3.4.4.1, Figure 3.3})$$

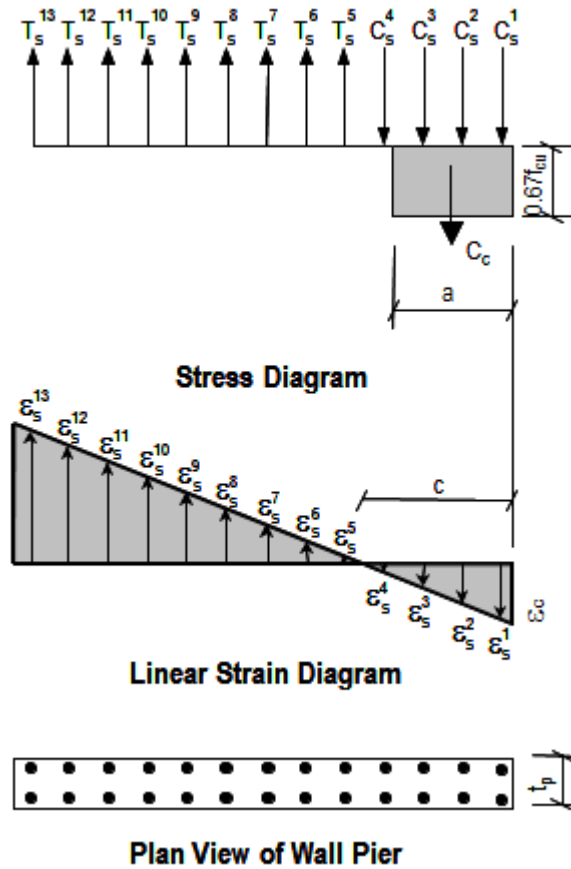

Figure 3-11: Wall Pier Stress-Strain Relationship

In Figure 3-10, the value for maximum strain in the reinforcing steel is assumed. Then the strain in all other reinforcing steel is determined based on the assumed plane of linear strain. Next the stress in the reinforcing steel is calculated using the following equation, where ϵ_s is the strain, E_s is the modulus of elasticity, σ_s is the stress, and f_y is the yield stress of the reinforcing steel.

$$\sigma_s = \epsilon_s E_s \leq f_y / \gamma_s \quad (\text{BS 3.4.4.1, Figure 2.2})$$

The force in the reinforcing steel (T_s for tension or C_s for compression) is calculated using the preceding equation where:

$$T_s \text{ or } C_s = \sigma_s A_s \quad (\text{BS 3.4.4.1})$$

For the given distribution of strain, the value of N_r is calculated using the following equation:

$$N_r = (\sum T_s - C_c - \sum C_s) \leq N_{\max} \quad (\text{BS 3.4.4.1})$$

In the previous equation, the tensile force T_s and the compressive forces C_c and C_s are all positive. If N_r is positive, it is tension, and if it is negative, it is compression. The term N_{\max} is taken as $N_{r,\max}$ if N_r is compressive, and as $N_{r,\max}$ if N_r is tensile.

The value of $M2_r$ is calculated by summing the moments due to all of the forces about the pier local 2 axis. Similarly, the value of $M3_r$ is calculated by summing the moments due to all of the forces about the pier local 3 axis. The forces whose moments are summed to determine $M2_r$ and $M3_r$ are N_r , C_c , all of the T_s forces and all of the C_s forces.

The N_r , $M2_r$ and $M3_r$ values calculated as described in the preceding paragraph make up one point on the wall pier interaction diagram. Additional points on the diagram are obtained by making different assumptions for the maximum steel stress, that is, considering a different plane of linear strain, and repeating the process.

When one interaction curve is complete, the next orientation of the neutral axis is assumed, and the points for the associated new interaction curve are calculated. This process continues until the points for all of the specified curves have been calculated.

3.1.3 Wall Pier Demand/Capacity Ratio

Refer to Figure 3-12, which shows a typical two-dimensional wall pier interaction diagram.

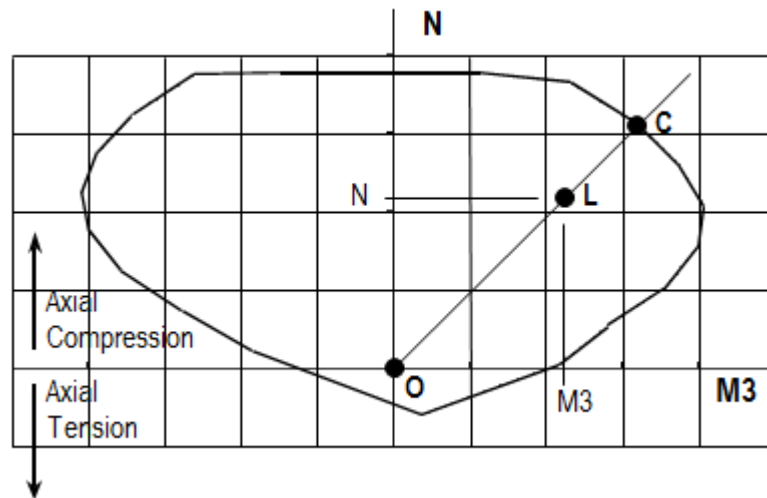

Figure 3-12: Two-Dimensional Wall Pier Demand/Capacity Ratio

The forces obtained from a given design load combination are N and $M3$. The point L , defined by $(N, M3)$, is placed on the interaction diagram, as shown in the figure. If the point lies within the interaction curve, the wall pier capacity is adequate. If the point lies outside of the interaction curve, the wall pier is overstressed.

As a measure of the stress condition in the wall pier, the program calculates a stress ratio. The ratio is achieved by plotting the point L and determining the location of point C . The point C is defined as the point where the line OL (extended outward if needed) intersects the interaction curve. The demand/capacity ratio, D/C , is given by $D/C = OL / OC$ where OL is the "distance" from point O (the origin) to point L and OC is the "distance" from point O to point C . Note the following about the demand/capacity ratio:

- If $OL = OC$ (or $D/C = 1$), the point $(N, M3)$ lies on the interaction curve and the wall pier is stressed to capacity.
- If $OL < OC$ (or $D/C < 1$), the point $(N, M3)$ lies within the interaction curve and the wall pier capacity is adequate.

- If $OL > OC$ (or $D/C > 1$), the point $(N, M3)$ lies outside of the interaction curve and the wall pier is overstressed.

The wall pier demand/capacity ratio is a factor that gives an indication of the stress condition of the wall with respect to the capacity of the wall. The demand/capacity ratio for a three-dimensional wall pier is determined in a similar manner to that described here for two-dimensional piers.

3.1.4 Designing a General Reinforcing Pier Section

When a General Reinforcing pier section is specified to be designed, the program creates a series of interaction surfaces for the pier based on the following items:

- The size of the pier as specified in Section Designer.
- The location of the reinforcing specified in Section Designer.
- The size of each reinforcing bar specified in Section Designer *relative* to the size of the other bars.

The interaction surfaces are developed for eight different ratios of reinforcing-steel-area-to-pier-area. The pier area is held constant and the rebar area is modified to obtain these different ratios; however, the *relative* size (area) of each rebar compared to the other bars is always kept constant.

The smallest of the eight reinforcing ratios used is that specified in the shear wall design preferences as Section Design IP-Min. Similarly, the largest of the eight reinforcing ratios used is that specified in the shear wall design preferences as Section Design IP-Max.

The eight reinforcing ratios used are the maximum and the minimum ratios plus six more ratios. The spacing between the reinforcing ratios is calculated as an increasing arithmetic series in which the space between the first two ratios is equal to one-third of the space between the last two ratios. Table 3-1 illustrates the spacing, both in general terms and for a specific example, when the minimum reinforcing ratio, IP_{min} , is 0.0025 and the maximum, IP_{max} , is 0.02.

Table 3-1 The Eight Reinforcing Ratios Used by the Program

Curve	Ratio	Example
1	IPmin	0.0025
2	$IPmin + \frac{IPmax - IPmin}{14}$	0.0038
3	$IPmin + \frac{7}{3} \left(\frac{IPmax - IPmin}{14} \right)$	0.0054
4	$IPmin + 4 \left(\frac{IPmax - IPmin}{14} \right)$	0.0075
5	$IPmin + 6 \left(\frac{IPmax - IPmin}{14} \right)$	0.0100
6	$IPmin + \frac{25}{3} \left(\frac{IPmax - IPmin}{14} \right)$	0.0129
7	$IPmin + 11 \left(\frac{IPmax - IPmin}{14} \right)$	0.0163
8	IPmax	0.0200

After the eight reinforcing ratios have been determined, the program develops interaction surfaces for all eight of the ratios using the process described earlier in the section entitled "Checking a General or Uniform Reinforcing Pier Section."

Next, for a given design load combination, the program generates a demand/capacity ratio associated with each of the eight interaction surfaces. The program then uses linear interpolation between the eight interaction surfaces to determine the reinforcing ratio that gives a demand/capacity ratio of 1 (actually the program uses 0.99 instead of 1). This process is repeated for all design load combinations, and the largest required reinforcing ratio is reported.

Design of a Uniform Reinforcing pier section is similar to that described herein for the General Reinforcing section.

3.2 Wall Pier Shear Design

The wall pier shear reinforcing is designed for each of the design load combinations. The following steps are involved in designing the shear reinforcing for a particular wall pier section for a particular design loading combination.

- Determine the factored forces N , M and V that are acting on the wall pier section. Note that N and M are required for the calculation of V_c .
- Determine the shear force, V_c , that can be carried by the concrete.
- Determine the required shear reinforcing to carry the balance of the shear force.

Step 1 needs no further explanation. The following two sections describe in detail the algorithms associated with the Steps 2 and 3.

3.2.1 Determine the Concrete Shear Capacity

Given the design force set N , M and V acting on a wall pier section, the shear force carried by the concrete, v'_c , is calculated as follows:

$$v'_c = v_c + 0.6 \frac{N}{A_c} \frac{Vh}{M}, \text{ with} \quad (\text{BS 3.4.5.12})$$

$$v_c = \frac{0.79k_1k_2}{\gamma_m} \left(\frac{100A_s}{bd} \right)^{1/3} \left(\frac{400}{d} \right)^{1/4}, \quad (\text{BS 3.4.5.4, Table 3.8})$$

where,

k_1 is the enhancement factor for support compression
and conservatively is taken as 1, (BS 3.4.5.8)

$$k_2 = \left(\frac{f_{cu}}{25} \right)^{1/3}, \quad (\text{BS 3.4.5.4, Table 3.8})$$

$$\gamma_m = 1.25. \quad (\text{BS 2.4.4.1})$$

However the following limitations also apply:

$$0.15 \leq \frac{100A_s}{bd} \leq 3, \quad (\text{BS 3.4.5.4, Table 3.8})$$

$$\frac{Vh}{M} \leq 1, \quad (\text{BS 3.4.5.4, Table 3.8})$$

$$\left(\frac{400}{d}\right)^4 \geq \begin{cases} 0.67 & \text{for members without shear reinforcement} \\ 1.00 & \text{for members with shear reinforcement,} \end{cases} \quad (\text{BS 3.4.5.4, Table 3.8})$$

$$f_{cu} \leq 40 \text{ N/mm}^2, \quad (\text{BS 6.1.2.5, 6.1.2.5(c)})$$

N/A_c is intended to be the average stress in the concrete acting at the centroid (BS 3.4.5.4, Table 3.8)

A_s is the area of tensile steel and it is taken as half the total reinforcing steel area, and

d is the distance from extreme compression fiber to the centroid of the tension steel. It is taken as $0.8 L_p$.

If the tension is large enough that v'_c results in a negative number, v_c is set to zero.

3.2.2 Determine the Required Shear Reinforcing

Given V and v_c , the following procedure provides the required shear reinforcing in area per unit length (e.g., square millimeter per millimeter or optionally cm^2/cm) for wall piers (BS 3.4.5.3, Table 3.7).

$$v = \frac{V}{A_{cv}}, A_{cv} = t_p d, \text{ where} \quad (\text{BS 3.4.5.2})$$

$$v \leq 0.8 R_{LW} \sqrt{f_{cu}}, \text{ and} \quad (\text{BS 3.4.5.2, BS 3.4.5.12})$$

$$v \leq 5 \text{ N/mm}^2. \quad (\text{BS 3.4.5.2, BS 3.4.5.12})$$

- If v exceeds $0.8 R_{LW} \sqrt{f_{cu}}$ or 5 N/mm^2 , the section area should be increased (BS 3.4.5.2, BS 3.4.5.12).

Calculate the design average shear stress that can be carried by minimum transverse rebar, v_r , as follows:

$$v_r = 0.4 \text{ N/mm}^2 \quad (\text{BS 3.4.5.2, 3.4.5.12})$$

- If $v \leq v'_c + v_r$ provide minimum links defined by

$$\frac{A_{sv}}{s_v} = \frac{v_r t_p}{0.87 f_{yv}}, \quad (\text{BS 3.4.5.3, Table 3.7})$$

else if $v > v'_c + v_r$, provide links given by

$$\frac{A_{sv}}{s_v} = \frac{(v - v'_c) t_p}{0.87 f_{yv}}. \quad (\text{BS BS 3.4.5.3, Table 3.7})$$

A_w/s_v is the horizontal shear reinforcing per unit vertical length (height) of the wall pier. In shear design, f_y cannot be taken as greater than 460 MPa (BS 3.4.5.1). If f_y for shear rebar is defined as greater than 460 MPa, the program designs shear rebar based on f_y equal to 460 MPa.

Chapter 4 Spandrel Design

This chapter describes how the program designs concrete shear wall spandrels for flexure and shear when BS 8110-1997 is the selected design code. Reference to the BS 8110-1997 code in this chapter is identified with the prefix “**BS.**” The program allows consideration of rectangular sections and T-beam sections for shear wall spandrels. Note that the program designs spandrels at stations located at the ends of the spandrel. No design is performed at the center (mid-length) of the spandrel. The program does not allow shear reinforcing to be specified and then checked. The program designs the spandrel for shear only and reports how much shear reinforcing is required.

4.1 Spandrel Flexural Design

In this program, wall spandrels are designed for major direction flexure and shear only. Effects caused by any axial forces, minor direction bending, torsion or minor direction shear that may exist in the spandrels must be investigated by the user independent of the program. Spandrel flexural reinforcing is designed for each of the design load combinations. The required area of reinforcing for flexure is calculated and reported at the ends of the spandrel beam only.

The following steps are involved in designing the flexural reinforcing for a particular wall spandrel section for a particular design loading combination at a particular station.

- Determine the maximum factored moment M .
- Determine the required flexural reinforcing.

These steps are described in the following sections.

4.1.1 Determine the Maximum Factored Moments

In the design of flexural reinforcing for spandrels, the factored moments for each design load combination at a particular beam station are first obtained.

The beam section is then designed for the maximum positive and the maximum negative factored moments obtained from all of the design load combinations.

4.1.2 Determine the Required Flexural Reinforcing

In this program, negative beam moments produce top steel. In such cases, the beam is always designed as a rectangular section.

In this program, positive beam moments produce bottom steel. In such cases, the beam may be designed as a rectangular section, or as a T beam section. Indicate that a spandrel is to be designed as a T beam by specifying the appropriate slab width and depth dimensions in the spandrel design overwrites (Appendix B).

The flexural design procedure is based on the simplified rectangular stress block, as shown in Figure 4-1 (BS 3.4.4.1). Furthermore, it is assumed that moment redistribution in the member does not exceed 10% (i.e., $\beta_b \geq 0.9$) (BS 6.1.2.4(b)). The code also places a limitation on the neutral axis depth, to safeguard against non-ductile failures (BS 3.4.4.1). In addition, the area of compression reinforcement is calculated on the assumption that the neutral axis depth remains at the maximum permitted value.

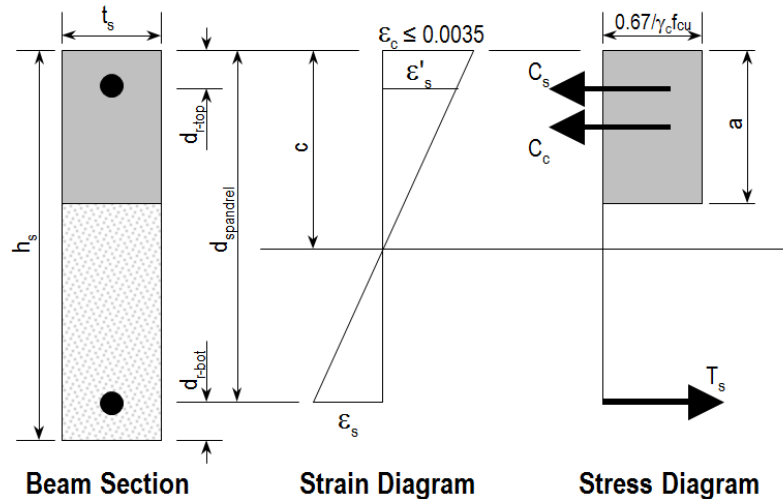

Figure 4-1 Rectangular Spandrel Beam Design, Positive Moment

The design procedure used by the program, for both rectangular and flanged sections (L and T beams), is summarized in the subsections that follow. It is assumed that the design ultimate axial force does not exceed $0.1f_{cu}A_g$ (BS 3.4.4.1); hence, all of the beams are designed for major direction flexure and shear only.

It is assumed that the compression depth carried by the concrete is less than or equal to a_{max} . When the applied moment exceeds the moment capacity at a_{max} , the program calculates an area of compression reinforcement assuming that the additional moment is carried by compression reinforcing and additional tension reinforcing.

The procedure used by the program for both rectangular and T beam sections is given in the subsections that follow.

4.1.2.1 Rectangular Beam Flexural Reinforcing

Refer to Figure 4-1. For rectangular beams, the moment capacity as a singly reinforced beam, M_{single} , is obtained first for a section. The reinforcing steel area is determined based on whether M is greater than, less than, or equal to M_{single} .

- Calculate the ultimate moment of resistance of the section as singly reinforced.

$$M_{\text{single}} = K' f_{cu} b d^2, \text{ where} \quad (\text{BS 3.4.4.4})$$

$$K' = 0.156$$

4.1.2.1.1 Tension Reinforcing Only Required

If $M \leq M_{\text{single}}$, the area of tension reinforcement, A_s , is obtained from

$$A_s = \frac{M}{(0.87 f_y) z}, \text{ where} \quad (\text{BS 3.4.4.4})$$

$$z = d \left\{ 0.5 + \sqrt{0.25 - \frac{K}{0.9}} \right\} \leq 0.95d,$$

and,

$$K = \frac{M}{f_{cu} t_s d^2}.$$

The steel is placed at the bottom for positive moment and at the top for negative moment.

Note: The program reports the ratio of top and bottom steel required in the web area. When compression steel is required, those ratios may be large because there is no limit on them. However, the program reports an overstress when the ratio exceeds 4%.

4.1.2.1.2 Tension and Compression Reinforcing Required

If $M > M_{\text{single}}$, the area of compression reinforcement, A'_s , is given by

$$A'_s = \frac{M - M_{\text{single}}}{\left(f'_s - \frac{0.67 f_{cu}}{\gamma_m} \right) (d - d')} \quad (\text{BS 3.4.4.4})$$

where d' is the depth of the compression steel from the concrete compression face, and

$$f'_s = 0.87 f_y \quad \text{if } d'/d \leq \frac{1}{2} \left[1 - \frac{f_y}{800} \right] \quad (\text{BS 3.4.4.4})$$

$$f'_s = E_s \varepsilon_c \left[1 - \frac{2d'}{d} \right] \quad \text{if } d'/d > \frac{1}{2} \left[1 - \frac{f_y}{800} \right] \quad (\text{BS 3.4.4.4})$$

$$z = d_{\text{Spandrel}} \left\{ 0.5 + \sqrt{0.25 - \frac{K'}{0.9}} \right\}. \quad (\text{BS 3.4.4.4})$$

This is the bottom steel if the section is under negative moment. From equilibrium, the area of tension reinforcement is calculated as

$$A_s = \frac{M_{\text{single}}}{0.87 f_y z} + \frac{M - M_{\text{single}}}{0.87 f_y (d - d')} \quad (\text{BS 3.4.4.4})$$

4.1.2.2 T-Beam Flexural Reinforcing

T-beam action is considered effective for positive moment only. When designing T-beams for negative moment (i.e., designing top steel), the calculation of required steel is as described in the previous section for rectangular sections. No T-beam data is used in this design. The width of the beam is taken equal to the width of the web.

With the flange in compression, the program analyzes the section by considering alternative locations of the neutral axis. Initially, the neutral axis is assumed to be located in the flange. Based on this assumption, the program calculates the exact depth of the neutral axis. If the stress block does not extend beyond the flange thickness, the section is designed as a rectangular beam of width b_f . If the stress block extends beyond the flange width, the contribution of the web to the flexural strength of the beam is taken into account. See Figure 4-2.

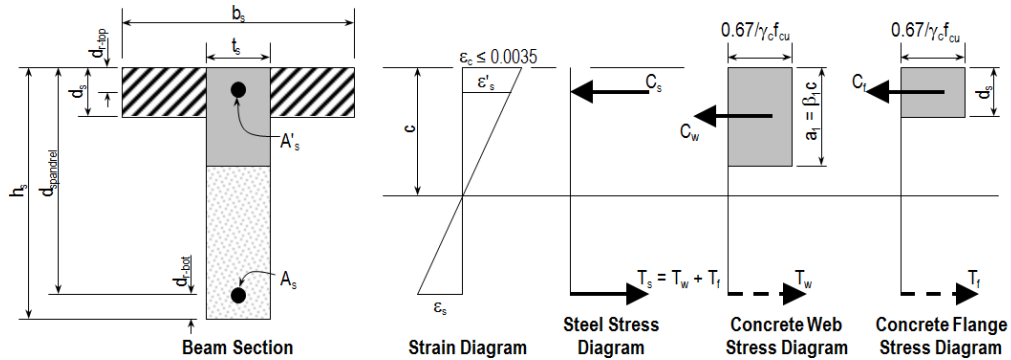

Figure 4-2: Design of a Wall Spandrel with a T-Beam Section, Positive Moment

- If $a \leq d_s$, the subsequent calculations for A_s are exactly the same as previously defined for the Rectangular section design. However, in that case, the width of the compression flange, b_f , is taken as the width of the beam, b , for analysis. Compression reinforcement is required if $K > K'$.
- If $a > d_s$, the subsequent calculations for the required area of reinforcing steel are performed in two parts. First, the tension steel required to balance the compressive force in the flange is determined, and second, the tension steel required to balance the compressive force in the web is determined. If necessary, compression steel is added to help resist the design moment.

The remainder of this section describes in detail the design process used by the program for T-beam spandrels when $a > d_s$.

Note: T-beam action is considered for positive moment only.

In that case, the ultimate resistance moment of the flange is given by

$$M_f = \frac{0.67}{\gamma_c} f_{cu} (b_f - t_s) d_s (d_{\text{Spandrel}} - 0.5d_s),$$

the balance of moment taken by the web is computed as

$$M_w = M - M_f, \text{ and}$$

the normalized moment resisted by the web is given by

$$K_w = \frac{M_w}{f_{cu} t_s d_{\text{Spandrel}}^2}$$

4.1.2.2.1 Tension Reinforcing Only Required

If $K_w \leq K_1$, the beam is designed as a singly reinforced concrete beam. The area of steel is calculated as the sum of two parts, one to balance compression in the flange and one to balance compression in the web.

$$A_s = \frac{M_f}{0.87 f_y (d_{\text{Spandrel}} - 0.5 d_s)} + \frac{M_w}{0.87 f_y z}, \text{ where}$$

$$z = d_{\text{Spandrel}} \left\{ 0.5 + \sqrt{0.25 - \frac{K_w}{0.9}} \right\} \leq 0.95 d_{\text{Spandrel}}$$

4.1.2.2.2 Tension and Compression Reinforcing Required

If $K_w > K'$, compression reinforcement is required and is calculated as follows:

The ultimate moment of resistance of the web only is given by

$$M_{uw} = K' f_{cu} t_s d_{\text{Spandrel}}^2$$

The compression reinforcement is required to resist a moment of magnitude $M_w - M_{uw}$. The compression reinforcement is computed as

$$A'_s = \frac{M_w - M_{uw}}{f'_s (d_{\text{Spandrel}} - d')}$$

where, d' is the depth of the compression steel from the concrete compression face, and

$$f'_s = 0.87 f_y \quad \text{if } d'/d \leq \frac{1}{2} \left[1 - \frac{f_y}{800} \right] \quad (\text{BS 3.4.4.4})$$

$$f'_s = E_s \varepsilon_c \left[1 - \frac{2d'}{d} \right] \text{ if } d'/d > \frac{1}{2} \left[1 - \frac{f_y}{800} \right] \quad (\text{BS 3.4.4.4})$$

The area of tension reinforcement is obtained from equilibrium

$$A_s = \frac{1}{0.87f_y} \left[\frac{M_f}{d_{\text{Spandrel}} - 0.5d_s} + \frac{M_{uw}}{z} + \frac{M_w - M_{uw}}{d_{\text{Spandrel}} - d'} \right], \text{ where}$$

$$z = d_{\text{Spandrel}} \left\{ 0.5 + \sqrt{0.25 + \frac{k'}{0.9}} \right\} \leq 0.95d_{\text{Spandrel}}.$$

The total tension reinforcement, A_s , is to be placed at the bottom of the beam, and A'_s at the top of the beam.

4.1.2.2.3 Minimum and Maximum Tensile Reinforcement

The minimum flexural tensile steel required for a beam section is given by the following table, which is taken from BS Table 3.25 (BS 3.12.5.3) with interpolation for reinforcement of intermediate strength:

Section	Situation	Definition of percentage	Minimum percentage	
			$f_y = 250 \text{ MPa}$	$f_y = 460 \text{ MPa}$
Rectangular	—	$100 \frac{A_s}{t_s h_s}$	0.24	0.13
T- or L-Beam with web in tension	$\frac{t_s}{b_f} < 0.4$	$100 \frac{A_s}{t_s h_s}$	0.32	0.18
	$\frac{t_s}{b_f} \geq 0.4$	$100 \frac{A_s}{t_s h_s}$	0.24	0.13
T-Beam with web in compression	—	$100 \frac{A_s}{t_s h_s}$	0.48	0.26
L-Beam with web in compression	—	$100 \frac{A_s}{t_s h_s}$	0.36	0.20

The minimum flexural compression steel provided in a rectangular or T-beam section, if it is required at all, is given by the following table, which is taken from BS Table 3.25 (BS 3.12.5.3) with interpolation for reinforcement of intermediate strength:

Section	Situation	Definition of percentage	Minimum percentage
Rectangular	—	$100 \frac{A'_s}{t_s h_s}$	0.20
T-Beam	Web in tension	$100 \frac{A'_s}{b_f d_s}$	0.40
	Web in compression	$100 \frac{A'_s}{t_s h_s}$	0.20

In addition, an upper limit on both the tension reinforcement and compression reinforcement has been imposed to be 0.04 times the gross cross-sectional area (BS 3.12.6.1).

4.2 Spandrel Shear Design

The program allows consideration of rectangular sections and T-beam sections for wall spandrels. The shear design for both of these types of spandrel sections is identical.

The wall spandrel shear reinforcing is designed for each of the design load combinations. The required area of reinforcing for vertical shear is calculated at the ends of the spandrel beam only.

In this program, wall spandrels are designed for major direction flexure and shear forces only. Effects caused by any axial forces, minor direction bending, torsion or minor direction shear that may exist in the spandrels must be investigated by the user independent of the program.

The following steps are involved in designing the shear reinforcing for a particular wall spandrel section for a particular design loading combination at a particular station.

- Determine the factored shear force V .

- Determine the shear force, v_c , that can be carried by the concrete.
- Determine the required shear reinforcing to carry the balance of the shear force.

Note: In the overwrites, v_c can be specified to be ignored (set to zero) for spandrel shear calculations.

Step 1 needs no further explanation. The following two sections describe in detail the algorithms associated with Steps 2 and 3.

4.2.1 Determine the Concrete Shear Capacity

The shear reinforcement is designed for each loading combination in the major and minor directions of the column. In designing the shear reinforcement for a particular beam for a particular loading combination due to shear forces in a particular direction, the following steps are involved:

- Calculate the design shear stress as

$$v = \frac{V}{A_{cv}}, A_{cv} = t_s d_{\text{Spandrel}}, \text{ where} \quad (\text{BS 3.4.5.2})$$

$$v \leq 0.8R_{LW} \sqrt{f_{cu}}, \text{ and} \quad (\text{BS 3.4.5.2})$$

$$v \leq 5 \text{ N/mm}^2. \quad (\text{BS 3.4.5.2})$$

If v exceeds either $0.8\sqrt{f_{cu}}$ or 5 N/mm^2 , the section area should be increased.

- Calculate the design concrete shear stress from

$$v'_c = v_c + 0.6 \frac{NVh}{A_c M} \leq v_c \sqrt{1 + \frac{N}{A_c v_c}} \quad (\text{BS 3.4.5.12})$$

$$v_c = \frac{0.79k_1k_2}{\gamma_m} \left(\frac{100A_s}{bd} \right)^{1/3} \left(\frac{400}{d} \right)^{1/4}, \quad (\text{BS 3.4.5.4, Table 3.8})$$

where,

k_1 is the enhancement factor for support compression,

and k_1 is conservatively taken as 1, (BS 3.4.5.8)

$$k_2 = \left(\frac{f_{cu}}{25} \right)^{1/3} \geq 1 \quad (\text{BS 3.4.5.4, Table 3.8})$$

$$\gamma_m = 1.25. \quad (\text{BS 2.4.4.1})$$

However, the following limitations also apply:

$$0.15 \leq \frac{100A_s}{bd} \leq 3, \quad (\text{BS 3.4.5.4, Table 3.8})$$

$$\left(\frac{400}{d} \right)^{1/4} \geq 0.67 \text{ (unreinforced) or } \geq 1 \text{ (reinforced)} \quad (\text{BS 3.4.5.4, Table 3.8})$$

$$f_{cu} \leq 40 \text{ MPa (for calculation purpose only)} \quad (\text{BS 3.4.5.4, Table 3.8})$$

$$\frac{Vh}{M} \leq 1 \quad (\text{BS 3.4.5.12})$$

Note: The term R_{LW} that is used as a multiplier on all $\sqrt{f_{cu}}$ terms in this manual is a shear strength reduction factor that applies to light-weight concrete. It is equal to 1 for normal weight concrete. This factor is specified in the concrete material properties.

4.2.2 Determine the Required Shear Reinforcing

One of the terms used in calculating the spandrel shear reinforcing is d_{spandrel} , which is the distance from the extreme compression fiber to the centroid of the tension steel. For shear design, the program takes d_{spandrel} to be equal to the smaller of $h_s - d_{r\text{-top}}$ and $h_s - d_{r\text{-bot}}$.

- Calculate the design average shear stress that can be carried by minimum transverse rebar, v_r as follows:

$$v_r = 0.4 \frac{N}{\text{mm}^2} \quad (\text{BS 3.4.5.3, Table 3.7})$$

A_s is the area of tensile steel.

If $v \leq v_c + v_r$, provide minimum links defined by

$$\frac{A_s}{s_v} = \frac{v_r b}{0.87 f_{yv}}, \quad (\text{BS 3.4.5.3, Table 3.7})$$

else if $v > v_c + v_r$, provide links given by

$$\frac{A_{sv}}{s_v} = \frac{(v - v_c) b}{0.87 f_{yv}}. \quad (\text{BS 3.4.5.3, Table 3.7})$$

Note: The output units for the distributed shear reinforcing can be set in the shear wall design preferences.

Chapter 5 Design Output

The program has the capacity to create design output in four major ways – graphical display, file output, tabular display, and member specific detailed design information. The graphical display includes input and output design information for members visible in the active window; the display can be sent directly to a printer or saved to a file. The file output includes both summary and detail design data that can be saved in RTF, HTML and plain text formats. The tabular display output includes both summary and detail design data that can be displayed or saved in many formats, including Excel, Access, RTF, HTML and plain text. The member specific detailed design information shows the details of the calculation.

The following sections describe some of the typical graphical display, file output, tabular display output, and member specific detailed design information. Some of the design information is very specific to the chosen shear wall design code. This manual addresses "Singapore CP 65:1999" design code related output information only.

5.1 Graphical Display of Design Information

The graphical display of design output includes input and output design information for all shear wall members that are visible in the active window. The graphical output can be produced in color or in gray-scaled screen

display. The active screen display can be sent directly to the printer or saved to a file in several formats.

Use the **Design menu > Shear Wall Design > Display Design Info** command to display on-screen output plotted directly on the model. If desired, the screen graphics can then be printed using the **File menu > Print Graphics** command. The on-screen display data is organized into two main groups, as follows.

Design Input

- Material
- Thickness
- Pier length/spandrel depth
- Section Designer pier sections

Design Output

- Simplified pier longitudinal reinforcing
- Simplified pier edge members
- Section Designer pier reinforcing ratios
- Section Designer pier D/C ratios
- Spandrel longitudinal reinforcing
- Shear reinforcing
- Pier demand/capacity ratios
- Pier boundary zones

Note that you cannot display more than one of the listed items on the model at the same time.

The output plotted directly on piers is plotted along an invisible line that extends from the centroid of the pier section at the bottom of the pier to the centroid of the pier section at the top of the pier. Similarly, the output plotted

directly on spandrels is plotted along an invisible line that extends from the centroid of the spandrel section at the left end of the spandrel to the centroid of the spandrel section at the top of the spandrel.

The onscreen graphical display can be sent to printer using any of the following commands. Use the **File menu > Print Graphics** command to print the active window. To capture the graphical display in a file for printing through another application, use the **File menu > Capture Enhanced Metafile** command to create an .emf file, or use the **File menu > Capture Picture** command to create a bitmap (.bmp) file. Create a screen capture of the active window using the **Alt+ Print Screen** keyboard keys or create a screen capture of the entire window using the **Ctrl + Print Screen** keyboard keys. Then use the **Ctrl+V** keyboard keys to paste the saved image into Paint or other graphical program.

5.2 Tabular Display of Design Information

In addition to model definition and analysis results, the design information for all piers and spandrels or for only selected piers and spandrels can be displayed in tabular spreadsheet format. Currently, the program generates design pier location data, pier basic overwrite data, uniform reinforcing sections, general reinforcing sections, simplified T and C sections, spandrel location data, spandrel basic overwrite data, and spandrel geometry data. The tabular spreadsheet output can be displayed by selecting the **Display menu > Show Tables** command to access the **Choose Tables for Display** form. That form can be used to choose which tables or sets of tables are to be displayed.

The names of the tables are displayed in a tree structure, which can be collapsed or expanded by clicking on an item in the tree. Click on the small check boxes preceding the items to select those tables for display. If a branch of the tree is selected, all of the tables under that branch are selected. The selected set of tables can be saved as a Named Set using the **Save Named Set** button. This named set can be used in the future for quick selection. If one or more frame members are selected on the structural model before accessing the Choose Tables for Display form, the Selection Only check box will be checked when the form displays and, the program will display information for the selected members only; uncheck the check box to display information for all applicable "unselected" members in the model. If the Show

Unformatted check box is checked, the numbers will be displayed unformatted, instead of being displayed using a limited number of decimal digits. The unformatted option provides higher precision output that can then be copied into other programs.

Use the other buttons in the form to tailor the data display. For example, click the **Select Load Cases** button to specify which load cases are to be included in the display of model definition data; click the **Select Analysis Case** and **Modify/Show Options** to specify which analysis cases are to be included and how analysis results are displayed.

After selecting all of the tables for shear wall design and the display options, click the **OK** button to display a form showing one of the selected design tables, with a drop-down list in the upper right-hand corner of the form that can be used to select other tables for display.

Use the scroll bars on the bottom and right side of the tables to scroll right and left or up and down if portions of the data table can not be displayed in the form's display area. The columns can be resized by clicking the left mouse button on the separator of the headers, holding down the left mouse button and then dragging the mouse to the left or right. Reset the column widths to their default values by selecting the **Format-Filter-Sort menu > Reset Default Column Widths** command on the form. The table can be split into two or more tables by clicking on the small black rectangular area near the bottom-left corner of the table, holding down the left mouse button, and then dragging the mouse button to the left or right. Repeat this process to add more splits. Use the split and horizontal scroll bar to put two columns side by side for easier comparison. The splits can be removed by selecting the **Format-Filter-Sort menu > Remove Splits** command on the form. Alternatively, remove the split by clicking, holding and dragging the left mouse button to merge the split key to its original location.

Select multiple consecutive columns by putting the cursor on the header, holding down the mouse button, and then dragging the mouse button left or right. Alternatively, depress the Shift key and click the left mouse button to select a range of columns.

Each of the individual fields (columns) can be formatted. Fields with text information can be set for specific types of alignment (center, left, right) and to specific widths. In addition to setting the alignment and column widths,

fields with numeric data can be set for the maximum number of characters, zero tolerance, number of decimal digits and so forth. The tables can be formatted, filtered and sorted using multiple criteria accessed using the **Format-Filter-Sort** menu on the form. Filtering and sorting features can be useful in identifying critical cases. After specifying the table formatting information, save it to a format file that can be used in the future by selecting the appropriate feature available under the **Format-Filter-Sort** menu.

The current table (i.e., the table in the active window) can be exported to Excel, Access, .rtf, .html, and plain text formats. In both Excel spreadsheet and Access database formats, the tables can have many columns, making the tables very wide. In .rtf and .html formats, the tables are split at convenient points to make a reasonably printable document. In plain text format, the tables can be saved with or without the splits. To export a table to Excel, for example, select the **File menu > Export Current Table > To Excel** command. The program will export the entire table to an Excel spreadsheet workbook and will automatically open the file in MS Excel. Similarly, if the table is exported to other formats, the default editor specific to that format will open the document, provided that the editor is available in the computer. The table will be saved in that format only if the relevant editor is not available. Instead of exporting or displaying the currently displayed table, the entire set of available tables can be exported and displayed in the aforementioned formats by selecting the File menu and the appropriate submenu command. With these exporting and display features, the tables can be saved in many required formats and can be printed. Many other features of the design tables are left for the user to discover by using the program.

5.3 Detailed Display of Member Specific Information

Interactive design is a powerful mode that allows quick, on-screen review of design results for a specific pier or spandrel. This mode allows easy modification to design parameters (overwrites) and immediate review of the new results.

Note that a design must have been run for the interactive design mode to be available. To run a design, click the **Design menu > Shear Wall Design > Start Design/Check of Structure** command.

To enter the interactive design and review mode, right click on a wall pier or spandrel *while the design results are displayed*. If design results are not currently displayed (and the design has been run), click the **Design menu > Shear Wall Design > Interactive Wall Design** command and then right click a pier or spandrel to enter the interactive design and review mode for that pier or spandrel.

Note that if both a pier and a spandrel label are assigned to the right-clicked object, a pop-up box offers the choice to enter the interactive design and review mode for the pier or for the spandrel. Appendix E provides additional information about interactive shear wall design.

5.4 Output of Design Information

In addition to model definition and analysis results, the design information for all piers and spandrels or for selected piers and spandrels only can be saved in tabular format. For BS 8110-1997 code, the program saves simplified pier longitudinal reinforcing, simplified pier edge members, Section Designer pier reinforcing ratios, section Designer pier D/C ratios, spandrel longitudinal reinforcing, shear reinforcing, pier demand/capacity ratios and pier boundary zones. Save the file output by selecting the **File menu > Print Tables** command to access the Choose Tables for Printing form. Use the options on the form to choose which table or set of tables to save in a file or print. This form is very similar to the Choose Tables for Display form, which has been described earlier in this chapter in the "Tabular Display of Design Information" section.

The name of the tables are displayed in a tree structure, which can be collapsed or expanded by clicking on an item in the tree. Click on the small check boxes preceding the items to select those tables for printing or saving to a file. If a branch of the tree is selected, all of the tables under that branch are selected. When all options for printing or saving the data to file have been specified, the settings can be saved as a Named Set using the **Save Named Set** button. The Named Set can be easily recalled in the future, reducing the need to reselect the options and ensuring that output is consistent from one printing effort to another.

If one or more structural members are selected before the Choose Tables for Printing form is accessed, the Selection Only check box will be checked, and

the program will save or print the data for the selected members only; uncheck the check box to save or print the data for all appropriate "unselected" members.

The output can be generated in a variety of formats, including rich text format (.rft), plain text with and without splits or page breaks (.txt), and hyperlink text markup language (.htm) by choosing the appropriate option on the right side of the form.

Printed output can be specified to have a landscaped orientation, in which the width of the resulting printout on a given page is longer than the height of the printout.

Filtering criteria can be applied if those criteria were specified using the **Format-Filter-Sort menu > Format Table** command when the selected data tables were displayed using the **Display menu > Show Tables** command. The output also can be specified to include a hyperlinked contents to facilitate accessing specific areas of the printout.

There are other buttons on the form that do not affect saving or printing design information. For example, the **Select Load Cases** button affects only saving/printing model definition data. The **Select Analysis Cases** and **Modify/Show Options** buttons affect only saving/printing analysis results.

After clicking all the necessary tables for steel frame design and all necessary options, clicking the **OK** button will save/print the design tables.

Although the **File name > Print Tables** command path is dedicated for saving/printing design information, it is not the only path to do so. Design tables can be saved in different formats using the path **Display menu > Show Tables** command.

5.5 Error Messages and Warnings

Error messages and warnings may be displayed in the shear wall design output. The messages are assumed to be self-explanatory.

Appendix A

Shear Wall Design Preferences

The shear wall design preferences are basic properties that apply to all wall pier and spandrel elements. Table B1 identifies shear wall design preferences for BS 8110-1997. Default values are provided for all shear wall design preference items. Thus, it is not required that preferences be specified. However, at least review the default values for the preference items to make sure they are acceptable. Refer to the program Help for an explanation of how to change a preference.

Table A1 Shear Wall Preferences

Item	Possible Values	Default Value	Description
Design Code	Any code in the program	UBC 97	Design code used for design of concrete shear wall elements (i.e., wall piers and spandrels)
Time History Design	Envelopes or Step-by-Step	Envelopes	Toggle for design load combinations that include a time history designed for the envelope of the time history, or designed step-by-step for the entire time history. If a single design load combination has <i>more than one</i> time history case in it, that design load combination is designed for the envelopes of the time histories, regardless of what is specified here.

Table A1 Shear Wall Preferences

Item	Possible Values	Default Value	Description
Rebar units	in ² , cm ² , mm ² , current	in ² or mm ²	Units used for concentrated areas of reinforcing steel..
Rebar/Length Units	in ² /ft, cm ² /m, mm ² /m, current	in ² /ft or mm ² /m	Units used for distributed areas of reinforcing steel.
Gamma (Steel)	> 0	1.15	The material strength reduction factor for Steel.
Gamma (Concrete)	> 0	1.5	The material strength reduction factor for Concrete.
Gamma (Concrete Shear)	> 0	1.25	The material strength reduction factor for Concrete in shear.
Number of Curves	≥ 4	24	Number of equally spaced interaction curves used to create a full 360-degree interaction surface (this item should be a multiple of four). We recommend that you use 24 for this item.
Number of Points	≥ 11	11	Number of points used for defining a single curve in a wall pier interaction surface (this item should be odd)..
Edge Design NT-max	> 0	0.06	Maximum ratio of tension reinforcing allowed in edge members, NT _{max} ..
Edge Design NC-max	> 0	0.04	Maximum ratio of compression reinforcing allowed in edge members, NC _{max} .
Section Design IP-Max	≥ Section Design IP-Min	0.02	The maximum ratio of reinforcing considered in the design of a pier with a Section Designer section.
Section Design IP-Min	> 0	0.0025	The minimum ratio of reinforcing considered in the design of a pier with a Section Designer section.
Utilization Factor limit	>0	0.95	Used to determine the capacity of the section.

Appendix B Design Procedure Overwrites

The shear wall design overwrites are basic assignments that apply only to those piers or spandrels to which they are assigned. The overwrites for piers and spandrels are separate. Tables B1 and B2 identify the shear wall overwrites for piers and spandrels, respectively, for BS 8110-1997. Note that the available overwrites change depending on the pier section type (Uniform Reinforcing, General Reinforcing, or Simplified T and C).

Default values are provided for all pier and spandrel overwrite items. Thus, it is not necessary to specify or change any of the overwrites. However, at least review the default values for the overwrite items to make sure they are acceptable. When changes are made to overwrite items, the program applies the changes only to the elements to which they are specifically assigned; that is, to the elements that are selected when the overwrites are changed. Refer to the program Help for an explanation of how to change the overwrites.

Table B-1: Pier Design Overwrites

Pier Overwrite Item	Possible Values	Default Value	Pier Overwrite Description
Design this Pier	Yes or No	Yes	Toggle to design the pier when the Design menu > Shear Wall Design > Start Design command is clicked.

Table B-1: Pier Design Overwrites

Pier Overwrite Item	Possible Values	Default Value	Pier Overwrite Description
LL Reduction Factor	Program calculated, > 0	Program calculated	A reducible live load is multiplied by this factor to obtain the reduced live load. Entering 0 for this item means that it is program calculated. See the "LL Reduction Factor" section in the appendix for more information.
Pier Section Type	Uniform Reinforcing, General Reinforcing, Simplified T and C	Uniform Reinforcing	Indicates the type of pier. The General Reinforcing option is not available unless General pier sections previously have been defined in Section Designer.
Overwrites Applicable to Uniform Reinforcing Pier Sections			
Edge Bar Name	Any defined bar size	Varies	The size of the uniformly spaced edge bars.
Edge Bar Spacing	>0	12"	The spacing of the uniformly spaced edge bars.
End/Corner Bar Name	Any defined bar size	Varies	The size of end and corner bars.
Clear Cover	>0	1.5"	The clear cover for the edge, end and corners bars.
Material	Any defined concrete material property	Varies	The material property associated with the pier.
Check/Design Reinforcing	Check or Design	Design	This item indicates if the pier section is to be designed or to be checked.
Overwrites Applicable to General Reinforcing Pier Sections			
Section Bottom	Any general pier section defined in Section Designer	The first pier in the list of Section Designer piers	Name of a pier section, defined in Section Designer that is assigned to the bottom of the pier.
Section Top	Any general pier section defined in Section Designer	The first pier in the list of Section Designer piers	Name of a pier section, defined in Section Designer, that is assigned to the top of the pier.
Check/Design Reinforcing	Check or Design	Design	This item indicates whether the pier section is to be designed or checked.

Table B-1: Pier Design Overwrites

Pier Overwrite Item	Possible Values	Default Value	Pier Overwrite Description
Overwrites Applicable to Simplified T and C Pier Sections			
ThickBot	Program calculated, or > 0	Program calculated	Wall pier thickness at bottom of pier, t_p . Inputting 0 means the item is to be program calculated.
LengthBot	Program calculated, or > 0	Program calculated	Wall pier length at bottom of pier, L_p . Inputting 0 means the item is to be program calculated.
DB1LeftBot	≥ 0	0	Length of the bottom of a user-defined edge member on the left side of a wall pier, $DB1_{left}$.
DB2LeftBot	≥ 0	0	Width of the bottom of a user-defined edge member on the left side of a wall pier, $DB2_{left}$. See Figure 1 in Shear Wall Design Technical Note 6 Wall Pier Design Section. See the subsection entitled "User-Defined Edge Members" for more information.
DB1RightBot	≥ 0	Same as $DB1_{left-bot}$	Length of the bottom of a user-defined edge member on the right side of a wall pier, $DB1_{right}$.
DB2RightBot	≥ 0	Same as $DB2_{left-bot}$	Width of the bottom of a user-defined edge member on the right side of a wall pier, $DB2_{right}$.
ThickTop	Program calculated, or > 0	Program calculated	Wall pier thickness at top of pier, t_p . Inputting 0 means the item is to be program calculated.
LengthTop	Program calculated, or > 0	Program calculated	Wall pier length at top of pier, L_p . Inputting 0 means the item is to be program calculated.
DB1LeftTop	≥ 0	0	Length of the top of a user-defined edge member on the left side of a wall pier, $DB1_{left}$.
DB2LeftTop	≥ 0	0	Width of the top of a user-defined edge member on the left side of a wall pier, $DB2_{left}$.
DB1RightTop	≥ 0	Same as $DB1_{left-bot}$	Length of the top of a user-defined edge member on the right side of a wall pier, $DB1_{right}$.
DB2RightTop	≥ 0	Same as $DB2_{left-bot}$	Width of the top of a user-defined edge member on the right side of a wall pier, $DB2_{right}$.

Table B-1: Pier Design Overwrites

Pier Overwrite Item	Possible Values	Default Value	Pier Overwrite Description
Material	Any defined concrete material property		Material property associated with the pier.
Edge Design NC-max	> 0	Specified in Preferences	Maximum ratio of compression reinforcing allowed in edge members, NC_{max} .
Edge Design NT-max	> 0	Specified in Preferences	Maximum ratio of tension reinforcing allowed in edge members, NT_{max} .

B.1 LL Reduction Factor

If the LL Reduction Factor is program calculated, it is based on the live load reduction method chosen in the live load reduction preferences (setting these preferences is explained in the program-specific on-line Help). If a user specifies a LL Reduction Factor, the program ignores any reduction method specified in the live load reduction preferences and simply calculates the reduced live load for a pier or spandrel by multiplying the specified LL Reduction Factor times the reducible live load.

Note that the steps required to define a load case as a reducible live load can be found in the program-specific on-line Help.

Important Note: The LL reduction factor is *not* applied to any load combination that is included in a design load combination. For example, assume two static load cases are labeled DL and RLL. DL is a dead load and RLL is a reducible live load. Now assume a design load combination named DESCOMB1 includes DL and RLL. Then for design load combination DESCOMB1, the RLL load is multiplied by the LL reduction factor. Next assume a load combination called COMB2 includes RLL. Now assume a design load combination is created called DESCOMB3 that included the DL and COMB2. For design load combination DESCOMB3, the RLL load that is part of COMB2 is *not* multiplied by the LL reduction factor.

B.2 User-Defined Edge Members

When defining a user-defined edge member, both a nonzero value for DB1 and a nonzero value for DB2 must be specified. If either DB1 or DB2 is

specified as zero, the edge member width is taken as the same as the pier thickness, and the edge member length is determined by the program.

Table B-2 Spandrel Design Overwrites

Spandrel Overwrite Item	Possible Values	Default Value	Spandrel Overwrite Description
Design this Spandrel	Yes or No	Yes	Toggle for design of the spandrel when you click the Design menu > Shear Wall Design > Start Design command.
LL Reduction Factor	Program calculated, > 0	Program calculated	A reducible live load is multiplied by this factor to obtain the reduced live load. Entering 0 for this item means that it is program calculated. See the "LL Reduction Factor" in this appendix for more information.
Length	Program calculated, or > 0	Program calculated	Wall spandrel length, L_s . Inputting 0 means the item is to be program calculated.
ThickLeft	Program calculated, or > 0	Program calculated	Wall spandrel thickness at left side of spandrel, t_s . Inputting 0 means the item is to be program calculated.
DepthLeft	Program calculated, or > 0	Program calculated	Wall spandrel depth at left side of spandrel, h_s . Inputting 0 means the item is to be program calculated.
CoverBotLeft	Program calculated, or > 0	Program calculated	Distance from bottom of spandrel to centroid of bottom reinforcing, $d_{r-bot\ left}$ on left side of beam. Inputting 0 means the item is to be program calculated as $0.1h_s$.
CoverTopLeft	Program calculated, or > 0	Program calculated	Distance from top of spandrel to centroid of top reinforcing, $d_{r-top\ left}$ on left side of beam. Inputting 0 means the item is to be program calculated as $0.1h_s$.
SlabWidthLeft	≥ 0	0	Slab width for T-beam at left end of spandrel, b_s .
SlabDepthLeft	≥ 0	0	Slab depth for T-beam at left end of spandrel, d_s .
ThickRight	Program calculated, or > 0	Program calculated	Wall spandrel thickness at right side of spandrel, t_s . Inputting 0 means the item is to be program calculated.
DepthRight	Program calculated, or > 0	Program calculated	Wall spandrel depth at right side of spandrel, h_s . Inputting 0 means the item is to be program calculated.

Table B-2 Spandrel Design Overwrites

Spandrel Overwrite Item	Possible Values	Default Value	Spandrel Overwrite Description
CoverBotRight	Program calculated, or > 0	Program calculated	Distance from bottom of spandrel to centroid of bottom reinforcing, $d_{r-bot\ right}$ on right side of beam. Inputting 0 means the item is to be program calculated as $0.1h_s$.
Cover-TopRight	Program calculated, or > 0	Program calculated	Distance from top of spandrel to centroid of top reinforcing, $d_{r-top\ right}$ on right side of beam. Inputting 0 means the item is to be program calculated as $0.1h_s$.
SlabWidthRight	≥ 0	0	Slab width for T-beam at right end of spandrel, b_s .
SlabDepthRight	≥ 0	0	Slab depth for T-beam at right end of spandrel, d_s .
Material	Any defined concrete material property	"Default Design Material Property	Material property associated with the spandrel.
Consider V_c	Yes or No	Yes	Toggle switch to consider V_c (concrete shear capacity) when computing the shear capacity of the spandrel.

Appendix C

Analysis Sections and Design Sections

It is important to understand the difference between analysis sections and design sections when performing shear wall design. Analysis sections are simply the objects defined in a model that make up the pier or spandrel section. The analysis section for wall piers is the assemblage of wall and column sections that make up the pier. Similarly, the analysis section for spandrels is the assemblage of wall and beam sections that make up the spandrel. The analysis is based on these section properties, and thus, the design forces are based on these analysis section properties.

The design section is completely separate from the analysis section. Two types of pier design sections are available.

- **Uniform Reinforcing Section:** For flexural designs and/or checks, the program automatically (and internally) creates a Section Designer pier section of the same shape as the analysis section pier. Uniform reinforcing is placed in this pier. The reinforcing can be modified in the pier overwrites. The Uniform Reinforcing Section pier may be planar or it may be three-dimensional.

For shear design and boundary zone checks, the program automatically (and internally) breaks the analysis section pier into planar legs and then performs the design on each leg separately and reports the results separately for each leg. Note that the planar legs are derived from the area objects defined in the

model, not from the pier section defined in Section Designer. The pier section defined in Section Designer is used for the flexural design/check only.

- **General Reinforcing Section:** For flexural designs and/or checks the pier geometry and the reinforcing is defined by the user in the Section Designer utility. The pier defined in Section Designer may be planar or it may be three-dimensional.

For shear design and boundary zone checks, the program automatically (and internally) breaks the analysis section pier into planar legs and then performs the design on each leg separately and reports the results separately for each leg. Note that the planar legs are derived from the area objects defined in the model, not from the pier section defined in Section Designer. The pier section defined in Section Designer is used for the flexural design/check only.

- **Simplified Pier Section:** This pier section is defined in the pier design overwrites. The simplified section is defined by a length and a thickness. The length is in the pier 2-axis direction and the thickness is in the pier 3-axis direction.

In addition, if desired, the thickened edge members at one or both ends of the simplified pier section can be specified. Reinforcing cannot be specified in a simplified section. Thus, the simplified section can be used for design only, not for checking user-specified sections. Simplified sections are always planar.

Only one type of spandrel design section is available. It is defined in the spandrel design overwrites. A typical spandrel is defined by a depth, thickness and length. The depth is in the spandrel 2-axis direction; the thickness is in the spandrel 3-axis direction; and the length is in the spandrel 1-axis direction. Spandrel sections are always planar. In addition, if desired, a slab thickness and depth can be specified, making the spandrel design section into a T-beam. Reinforcing cannot be specified in a spandrel section. Thus, spandrel sections can be designed only, not check.

The pier and spandrel design sections are designed for the forces obtained from the program's analysis, which is based on the analysis sections. In other words, the design sections are designed based on the forces obtained for the analysis sections.