



**Eurocode 3-2005
with Eurocode 8:2004
Steel Frame Design Manual**

for
SAP2000®

COPYRIGHT

Copyright © Computers and Structures, Inc., 1978-2016
All rights reserved.

The CSI Logo® and SAP2000® are registered trademarks of Computers and Structures, Inc. Adobe® and Acrobat® are registered trademarks of Adobe Systems Incorporated.

The computer program SAP2000® and all associated documentation are proprietary and copyrighted products. Worldwide rights of ownership rest with Computers and Structures, Inc. Unlicensed use of this program or reproduction of documentation in any form, without prior written authorization from Computers and Structures, Inc., is explicitly prohibited.

No part of this publication may be reproduced or distributed in any form or by any means, or stored in a database or retrieval system, without the prior explicit written permission of the publisher.

Further information and copies of this documentation may be obtained from:

Computers and Structures, Inc.
www.csiamerica.com

info@csiamerica.com (for general information)

support@csiamerica.com (for technical support questions)

DISCLAIMER

CONSIDERABLE TIME, EFFORT AND EXPENSE HAVE GONE INTO THE DEVELOPMENT AND TESTING OF THIS SOFTWARE. HOWEVER, THE USER ACCEPTS AND UNDERSTANDS THAT NO WARRANTY IS EXPRESSED OR IMPLIED BY THE DEVELOPERS OR THE DISTRIBUTORS ON THE ACCURACY OR THE RELIABILITY OF THIS PRODUCT.

THIS PRODUCT IS A PRACTICAL AND POWERFUL TOOL FOR STRUCTURAL DESIGN. HOWEVER, THE USER MUST EXPLICITLY UNDERSTAND THE BASIC ASSUMPTIONS OF THE SOFTWARE MODELING, ANALYSIS, AND DESIGN ALGORITHMS AND COMPENSATE FOR THE ASPECTS THAT ARE NOT ADDRESSED.

THE INFORMATION PRODUCED BY THE SOFTWARE MUST BE CHECKED BY A QUALIFIED AND EXPERIENCED ENGINEER. THE ENGINEER MUST INDEPENDENTLY VERIFY THE RESULTS AND TAKE PROFESSIONAL RESPONSIBILITY FOR THE INFORMATION THAT IS USED.

Contents

Chapter 1	Introduction	
1.1	Units	1-2
1.2	Axes Notation	1-2
1.3	Symbols	1-2
Chapter 2	Assumptions and Limitations	
2.1	Assumptions	2-1
2.1.1	General	2-1
2.1.2	Axial Force Check	2-2
2.1.3	Bending Moment Check	2-2
2.1.4	Shear Force Check	2-2
2.1.5	Combined Force Check	2-2
2.2	Limitations	2-4
2.2.1	General	2-4
2.2.2	Axial Force Check	2-4
2.2.3	Torsional Moment Check	2-5
2.2.4	Combined Force Check	2-5

Chapter 3	Design Flow Charts	
Chapter 4	General Design Parameters	
4.1	Partial Factors	4-1
4.2	Design Forces	4-1
4.3	Design Load Combinations	4-2
	4.3.1 Ultimate Strength Combinations	4-2
	4.3.2 Serviceability Combinations	4-4
4.4	Material Properties	4-4
4.5	Section Classification	4-5
Chapter 5	Design for Axial Forces	
5.1	Axial Area	5-1
5.2	Tension Check	5-2
5.3	Compression Check	5-2
5.4	Axial Buckling Check	5-3
5.5	Member Unsupported Lengths	5-5
5.6	Effective Length Factor (K)	5-8
Chapter 6	Design for Bending Moment	
6.1	Moment Check	6-1

	6.2	Lateral-Torsional Buckling Check	6-4
Chapter 7		Design for Shear Force	
	7.1	Shear Area	7-1
	7.2	Shear Check	7-1
	7.3	Shear Buckling Check	7-2
Chapter 8		Design for Torsion	
	8.1	Analysis of Torsion Stresses	8-1
	8.2	Shear Check in Presence of Torsion	8-2
	8.3	Design for Combined Actions	8-3
Chapter 9		Design for Combined Forces	
	9.1	Design for Cross-Section Resistance	9-2
	9.1.1	Bending, Axial Force, and Shear Check	9-2
	9.1.2	Members Subjected to Shear Force	9-7
	9.2	Design for Buckling Resistance of Members	9-8
	9.2.1	Class 1, 2, and 3 Sections Under Flexure and Axial Compression	9-8
	9.2.2	Class 4 Sections Under Flexure and Axial Compression	9-9
	9.2.3	Class 1, 2, and 3 Sections Under Flexure and Axial Tension	9-10
	9.2.4	Class 4 Sections Under Flexure and Axial Tension	9-10
Chapter 10		Special Seismic Provisions	
	10.1	Design Preferences	10-1

10.2	Overwrites	10-2
10.3	Supported Framing Types	10-2
10.4	Member Design	10-3
10.4.1	Ductility Class High Moment-Resisting Frames (DCH MRF)	10-4
10.4.2	Ductility Class Medium Moment-Resisting Frames (DCM MRF)	10-6
10.4.3	Ductility Class Low Moment-Resisting Frames (DCL MRF)	10-6
10.4.4	Ductility Class High Concentrically Braced Frames (DCH CBF)	10-7
10.4.5	Ductility Class Medium Concentrically Braced Frames (DCM CBF)	10-9
10.4.6	Ductility Class Low Concentrically Braced Frames (DCL CBF)	10-9
10.4.7	Ductility Class High Eccentrically Braced Frames (DCH EBF)	10-10
10.4.8	Ductility Class Medium Eccentrically Braced Frames (DCM EBF)	10-13
10.4.9	Ductility Class Low Eccentrically Braced Frames (DCL EBF)	10-14
10.4.10	Inverted Pendulum	10-14
10.4.11	Secondary	10-15
10.5	Design of Joints Components	10-15
10.5.1	Design of Continuity Plates	10-16
10.5.2	Design of Supplementary Web Plates	10-22
10.5.3	Weak Beam/Strong Column Measure	10-26
10.5.4	Evaluation of Beam Connection Shears	10-28
10.5.5	Evaluation of Brace Connection Forces	10-29

Appendix A Design Preferences

Appendix B Design Overwrites

Appendix C Nationally Determined Parameters (NDPs)

References

Chapter 1

Introduction

This manual describes the steel frame design algorithms in the software for the “Eurocode 3-2005” [EN 1993-1-1] design code. The design algorithms in the software for Eurocode 3 cover strength checks, as detailed in this manual. Requirements of the code not documented in this manual should be considered using other methods.

The default implementation in the software is the CEN version of the code. Additional country specific National Annexes are also included. The Nationally Determined Parameters are noted in this manual with [*NDP*]. Changing the country in the Design Preferences will set the Nationally Determined Parameters for the selected country as defined in Appendix C.

It is important to read this entire manual before using the design algorithms to become familiar with any limitations of the algorithms or assumptions that have been made.

For referring to pertinent sections of the corresponding code, a unique prefix is assigned for each code.

- Reference to the EN 1993-1-1:2005 code is identified with the prefix “EC3.”
- Reference to the EN 1993-1-5:2006 code is identified with the prefix “EN 1993-1-5.”

- Reference to the ENV 1993-1-1:1992 code is identified with the prefix “EC3-1992.”
- Reference to the Eurocode 1990:2002 code is identified with the prefix “EC0.”

1.1 Units

The Eurocode 3 design code is based on Newton, millimeter, and second units and, as such, so is this manual, unless noted otherwise. Any units, imperial, metric, or MKS may be used in the software in conjunction with Eurocode 3 design.

1.2 Axes Notation

The software analysis results refer to the member local axes system, which consists of the 2-2 axis that runs parallel to the web and the 3-3 axis that runs parallel to the flanges. Therefore, bending about the 2-2 axis would generate minor axis moment, and bending about the 3-3 axis would generate major axis moment. The Eurocode 3 design code refers to y-y and z-z axes, which are equivalent to the software 3-3 and 2-2 axes, respectively. These notations may be used interchangeably in the design algorithms, although every effort has been made to use the design code convention where possible.

1.3 Symbols

The following table provides a list of the symbols used in this manual, along with a short description. Where possible, the same symbol from the design code is used in this manual.

<i>a</i>	Torsional bending constant. It is given by $a = \sqrt{(EI_w)/(GI_T)}$, where EI_w represents the warping stiffness and GI_T is the St Venant torsional stiffness. It generally expresses the rate at which the warping torsional moment diminishes from a position where warping is restrained, mm
----------	---

A	Gross area of cross section, mm ²
A_{net}	Net area of cross section, mm ²
A_v	Shear area, mm ²
A_w	Web area, mm ²
b	Width of the section, mm
C_I	Moment diagram factor
E	Modulus of elasticity, N/mm ²
f_u	Steel ultimate strength, N/mm ²
f_y	Steel yield strength, N/mm ²
f_{yw}	Steel yield strength of the web, N/mm ²
$F_{w,Ed}$	Design shear force in the flange due to warping moment, N
G	Shear modulus. It is given by $G = E/2(1 + \nu)$, where E is the modulus of elasticity and ν is the Poisson's ratio. For structural steel $E/G = 2.6$ and $G \approx 81,000$, N/mm ²
h	Depth of the section, mm
h_w	Web height, mm
I	Moment of inertia, mm ⁴
I_F	Moment of inertia of a flange of an I beam about its own center of gravity or about the minor axis of bending of the whole section, $I_F = t_f b_f^3 / 12$, mm ⁴
I_T	St. Venant torsional constant. It is the section property relating St. Venant torsional moment to the first derivative of rotation (twist per unit length). In many texts it is referred to as J , mm ⁴
I_w	Warping constant. It is the section property relating the warping torsional moment to the third derivative of rotation. In many texts it is referred to as H or C_w , mm ⁶
$k_{yy}, k_{zz}, k_{yz}, k_{zy}$	Interaction factors
L_{cr}	Buckling length, mm
$M_{b,Rd}$	Design buckling resistance moment, N-mm
$M_{c,Rd}$	Design bending resistance, N-mm

M_{Ed}	Design bending moment, N-mm
$M_{el,Rd}$	Elastic design bending resistance, N-mm
$M_{pl,Rd}$	Plastic design bending resistance, N-mm
M_{Rk}	Characteristic bending resistance, N-mm
$M_{w,Ed}$	Warping moment. It is the bending moment in a flange acting as a result of restraint of warping. The moment at the two flanges are equal and of opposite sign, N-mm
$M_{y,V,Rd}$	Reduced design bending resistance accounting for shear, N-mm
$M_{z,T,Ed}$	Additional bending moment about the minor axis caused by the rotation of the beam and torsion, N-mm
$N_{b,Rd}$	Design buckling resistance, N
N_{cr}	Elastic critical force, N
$N_{c,Rd}$	Design compression resistance, N
N_{Ed}	Design axial force, N
$N_{pl,Rd}$	Plastic design axial resistance, N
N_{Rk}	Characteristic compression resistance, N
$N_{t,Rd}$	Design tension resistance, N
$N_{u,Rd}$	Design ultimate tension resistance, N
t_f	Flange thickness, mm
t_w	Web thickness, mm
T_{Ed}	Design value of total torsional moment, N-mm
$T_{t,Ed}$	Design value of internal St Venant torsional moment, N-mm
$T_{w,Ed}$	Design value of internal warping torsional moment, N-mm
$V_{c,Rd}$	Design shear resistance, N
$V_{b,Rd}$	Design shear buckling resistance, N
$V_{bf,Rd}$	Flange contribution of the design shear buckling resistance, N
$V_{bw,Rd}$	Web contribution of the design shear buckling resistance, N
V_{Ed}	Design shear force, N

$V_{pl,Rd}$	Plastic design shear resistance, N
$V_{pl,T,Rd}$	Reduced design plastic shear resistance making allowance for the presence of a torsional moment, N
$W_{el,min}$	Minimum elastic section modulus, mm ³
W_{pl}	Plastic section modulus, mm ³
α, α_{LT}	Imperfection factor
χ	Reduction factor for buckling
χ_{LT}	Reduction factor for lateral-torsional buckling
χ_w	Web shear buckling contribution factor
ε	Coefficient dependent on f_y , $\varepsilon = \sqrt{235/f_y}$
ϕ	The angle of rotation of a cross-section about the longitudinal axis, rad
ϕ'	The first derivative of the angle of rotation of a cross-section about the longitudinal axis, $\phi' = d\phi/dx$, rad/mm
ϕ''	The second derivative of the angle of rotation of a cross-section about the longitudinal axis, $\phi'' = d^2\phi/dx^2$, rad/mm ²
ϕ'''	The third derivative of the angle of rotation of a cross-section about the longitudinal axis, $\phi''' = d^3\phi/dx^3$, rad/mm ³
Φ	Value for calculating the reduction factor χ
Φ_{LT}	Value for calculating the reduction factor χ_{LT}
γ_{M0}	Partial factor for resistance of cross-sections
γ_{M1}	Partial factor for resistance of members to instability
γ_{M2}	Partial factor for resistance of cross-sections in tension to fracture
η	Factor for shear area
$\bar{\lambda}$	Non-dimensional slenderness
$\bar{\lambda}_{LT}$	Non-dimensional slenderness for lateral-torsional buckling
$\bar{\lambda}_{LT,0}$	Plateau length of the lateral-torsional buckling curves

$\bar{\lambda}_w$	Slenderness parameter
ρ	Reduction factor accounting for shear forces
ρ_T	Reduction factor for design plastic shear resistance making allowance for the presence of a torsional moment. It is taken as $\rho_T = V_{pl,T,Rd} / V_{pl,Rd}$.
τ_{Ed}	Design shear stress at a point in a section, N/mm ²
$\tau_{t,Ed}$	Design shear stress due to St Venant torsion, N/mm ²
$\tau_{w,Ed}$	Design shear stress due to warping torsion, N/mm ²
ψ	Ratio of moments in a segment

Chapter 2

Assumptions and Limitations

This chapter describes the assumptions made and the limitations of the design algorithm for the “Eurocode 3-2005” steel frame design. All of the assumptions and limitations should be reviewed before using the design algorithm.

2.1 Assumptions

The assumptions made in the design algorithm are listed in the following sections, along with a description of how they may affect the design results.

2.1.1 General

The following assumptions apply generically to the design algorithm.

- The analysis model geometry, properties, and loads adequately represent the building structure for the limit states under consideration (EC3 5.1.1).
- It is assumed that the steel grades used adhere to “Eurocode 3-2005”, Table 3.1 or an associated National Annex (EC3 3.1(2)). The acceptable use of other materials shall be independently verified.
- The automated load combinations are based on the STR ultimate limit states and the characteristic serviceability limit states.

2.1.2 Axial Force Check

The following assumptions apply to the axial force check.

- Hot rolled tubular sections are assumed to be hot finished for selecting the appropriate buckling curve from EC3 Table 6.2. This is nonconservative if cold formed sections are used.
- For welded Box sections, if $b/t_f < 30$ and $h/t_w < 30$, it is assumed that the weld thickness is more than $0.5t_f$ (EC3 Table 6.2).

2.1.3 Bending Moment Check

The following assumptions apply to the bending moment check.

- The load is assumed to be applied at the shear center for the calculation of the elastic critical moment. Any eccentric moment due to load applied at other locations is not automatically accounted for.

2.1.4 Shear Force Check

The following assumptions apply to the shear force check.

- Plastic design is assumed such that $V_{c,Rd}$ is calculated in accordance with EC3 6.2.6(2).
- Transverse stiffeners exist only at the supports and create a non-rigid end post for the shear buckling check. No intermediate stiffeners are considered.
- The contribution from the flanges is conservatively ignored for the shear buckling capacity.

2.1.5 Torsional Moment Check

The following assumptions apply to the shear force check.

- Total torsional moment is split into a St Venant torsion $T_{t,Ed}$ and a warping torsion $T_{w,Ed}$.

- The warping torsion, $M_{w,Ed}$, contributes to the bending moment in the flanges. This affects the interaction checks. It also increases the minor axis bending moment by a small amount, $M_{z,T,Ed}$. The interaction equations are modified to accommodate the warping moment, $M_{w,Ed}$ and additional minor axis bending moment, $M_{z,T,Ed}$. The following equations are modified: Eq. 6.2 of section EC3 6.2.1(7), Eq. 6.41 of section EC3 6.2.9.1(6), Eq. 6.44 of section EC3 6.2.9.3(2). One additional interaction equation is checked which is given in Annex A of BS EN 1993-6.
- The effect of combined shear force and torsional moment in the reduction of section shear resistance is evaluated by using the section EC3 6.2.7(9).
- The elastic verification using the yield criterion given in EC3 6.2.1(5) is not used as this criterion is conservative. This criterion ignores the plastic stress redistribution.

In doing torsional moment check the book “Design of Steel Beams in Torsion in Accordance with Eurocodes and UK National Annexes”, the SCI Publication P385, is taken as the guide (Hughes, Iles, and Malik, 2011).

2.1.6 Combined Forces Check

The following assumptions apply to the combined forces check.

- The interaction of bending and axial force is checked for certain sections (shapes) and for certain classes of sections, in accordance with EC3 6.2.1(7), which may be conservative compared to EC3 6.2.9, when no special clause in EC3 6.2.9 is applicable to that shape and that class.
- The warping torsion, $M_{w,Ed}$, contributes to the bending moment in the flanges. This affects the interaction checks. It also increases the minor axis bending moment by a small amount, $M_{z,T,Ed}$. The interaction equations are modified to accommodate the warping moment, $M_{w,Ed}$ and additional minor axis bending moment, $M_{z,T,Ed}$. The following equations are modified: Eq. 6.2 of section EC3 6.2.1(7), Eq. 6.41 of section EC3 6.2.9.1(6), Eq. 6.44 of section EC3 6.2.9.3(2). One additional interaction equation is checked which is given in Annex A of BS EN 1993-6.

2.2 Limitations

The limitations of the design algorithm are listed in the following sections, along with a work around where possible.

2.2.1 General

The following limitations apply generically to the design algorithm.

- Sections with a material thickness, $t < 3$ mm are not designed (EC3 1.1.2(1)). The special requirements in accordance with EN 1993-1-3 for cold formed thin gauge members are not covered in this implementation (EC3 1.1.2(1)).
- The material yield is not adjusted based on the thickness of the section. Different material properties should be defined for sections of different thickness if the thickness affects the material yield value (EC3 3.2.1, Table 3.1).
- The effects of torsion are not considered in the design (EC3 6.2.7) and should be considered using other methods.
- The special requirements in accordance with Eurocode EN 1993-1-12 for high-strength steels above S460 currently are not considered.
- The special requirements in accordance with EN 1993-1-6 for Circular Hollow (tube) sections with Class 4 cross-sections are not covered in this implementation (EC3 6.2.2.5(5)).

2.2.2 Axial Force Check

The following limitations apply to the axial force check.

- The net area is not determined automatically. This can be specified on a member-by-member basis using the *Net Area to Total Area Ratio* overwrite.

2.2.3 Torsional Moment Check

The following limitations apply to the torsional moment check.

- The torsion check is limited to the following open section: Doubly-symmetric I-shapes. I-shapes with single symmetric sections are not checked for torsion.
- The torsion check is limited to the following closed sections: box and pipe shapes.

2.2.4 Combined Forces Check

The following limitations apply to the combined forces checks.

- The code allows the engineers to design the cross-sections with Class 3 web and Class 1 or 2 flanges as a Class 2 cross-section with an effective web area as specified in EC3 6.2.2.4 (EC3 5.5.2(11), EC3 6.2.2.4(1)). However, the program does not take this advantage, which is conservative.

Chapter 3

Design Flow Charts

The flow charts on the following pages provide a pictorial representation of the design algorithm for “Eurocode 3-2005” steel frame design. These flow charts provide a summary of the steps taken and the associated code clauses used. Additional detailed information defining the steps used in the algorithm is provided in the chapters that follow.

The following flow charts are provided:

- member design
- design axial resistance
- design axial buckling resistance
- design bending resistance
- design lateral-torsional buckling resistance
- design shear resistance

The flowcharts given in this chapter, in general, assume that there is no consideration for torsion. However, the program, can optionally do design checks for certain sections (I, Box, and Pipes) considering torsion. In doing so, the program uses modified versions of the interaction equations. This has been discussed in the appropriate chapters in details.

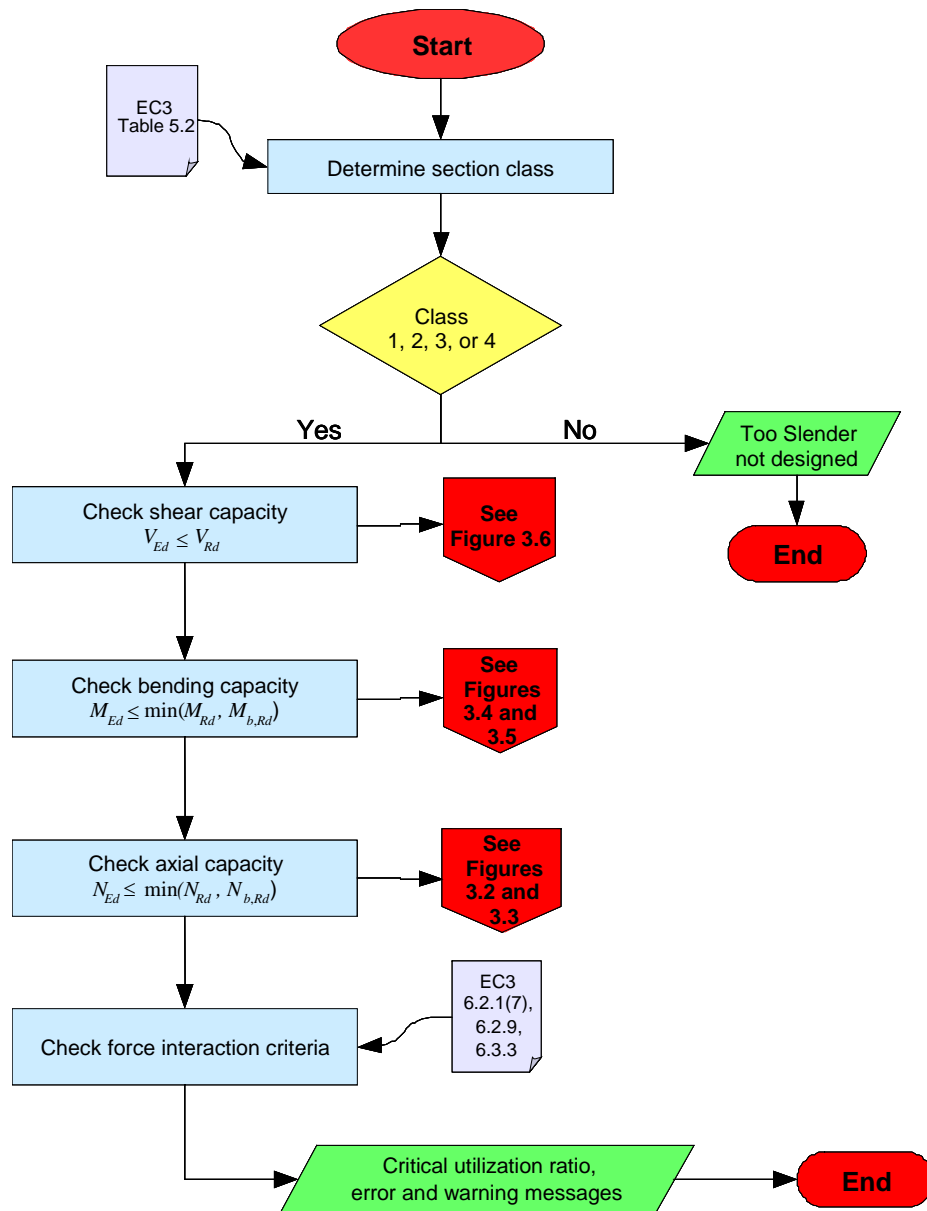

Figure 3-1 Member Design

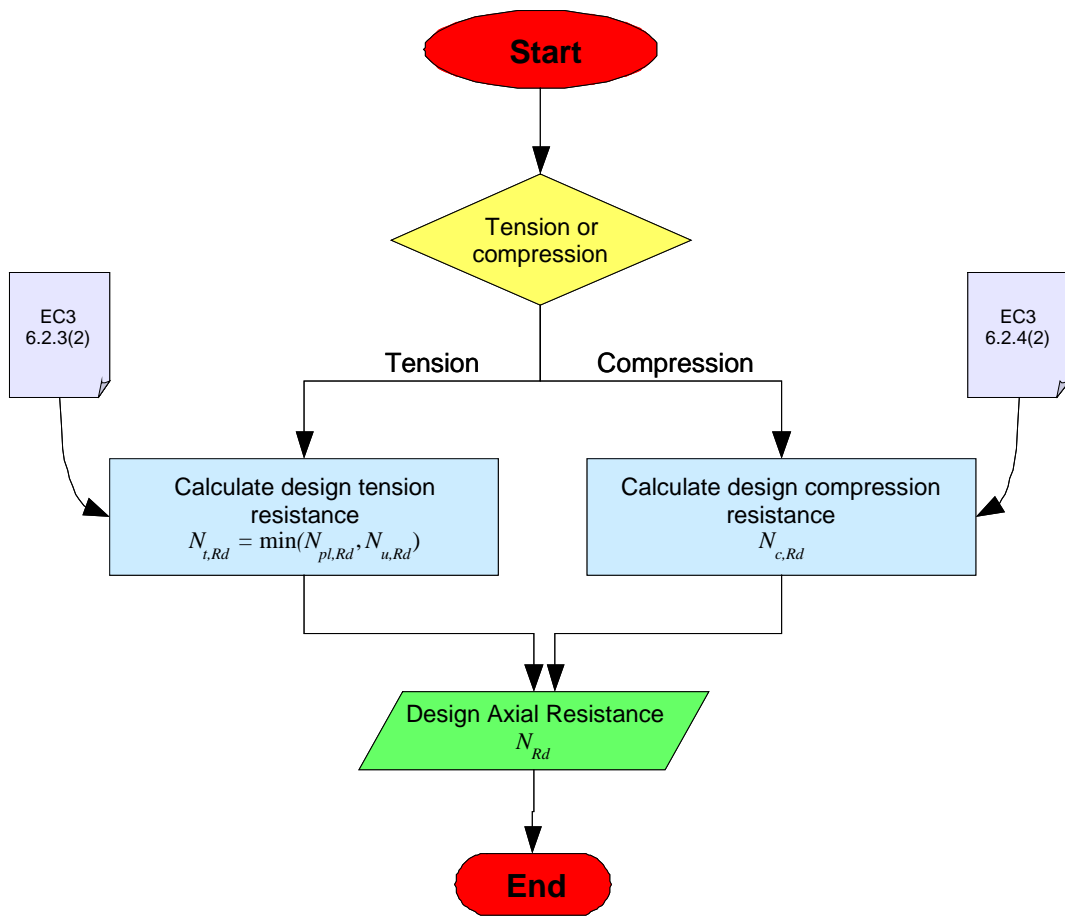

Figure 3-2 Design Axial Resistance

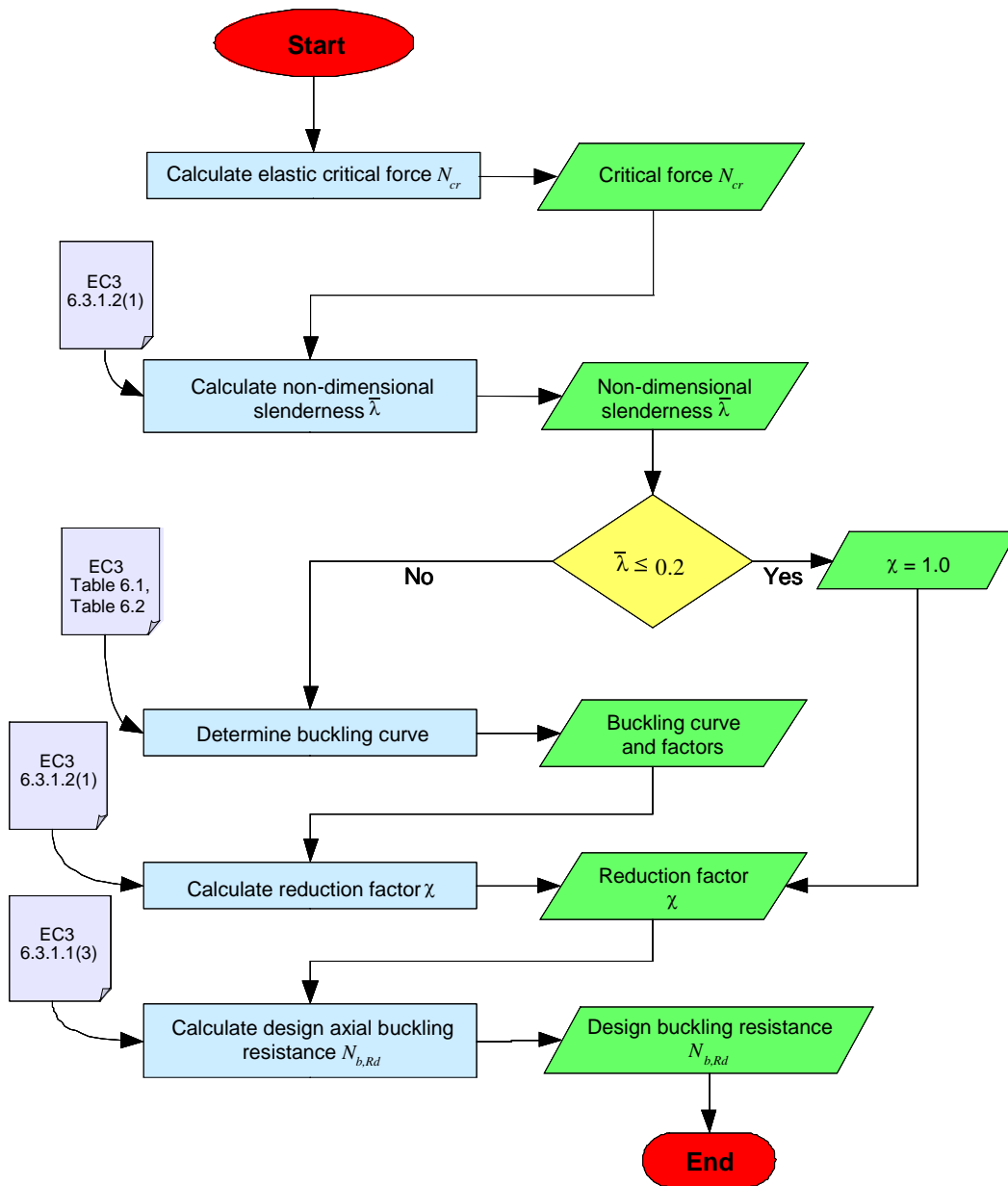

Figure 3-3: Design Axial Buckling Resistance

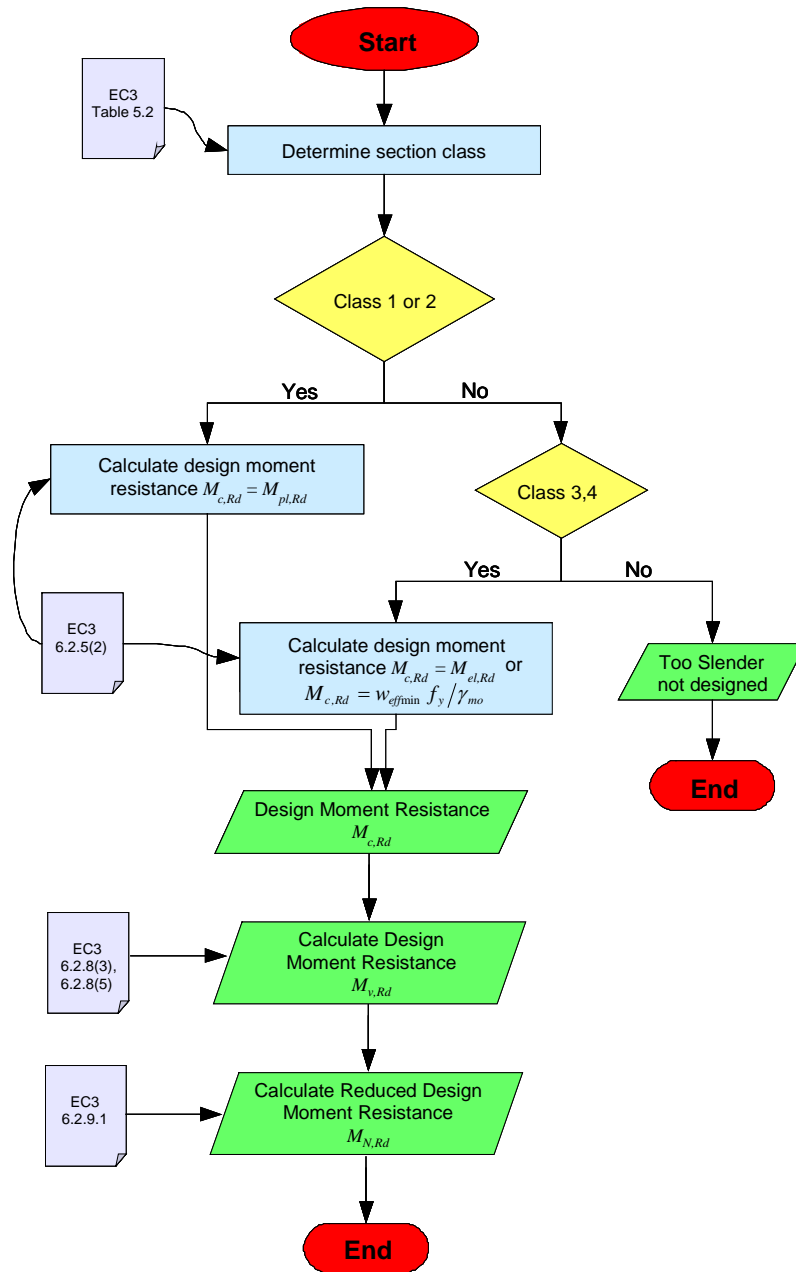

Figure 3-4: Design Moment Resistance

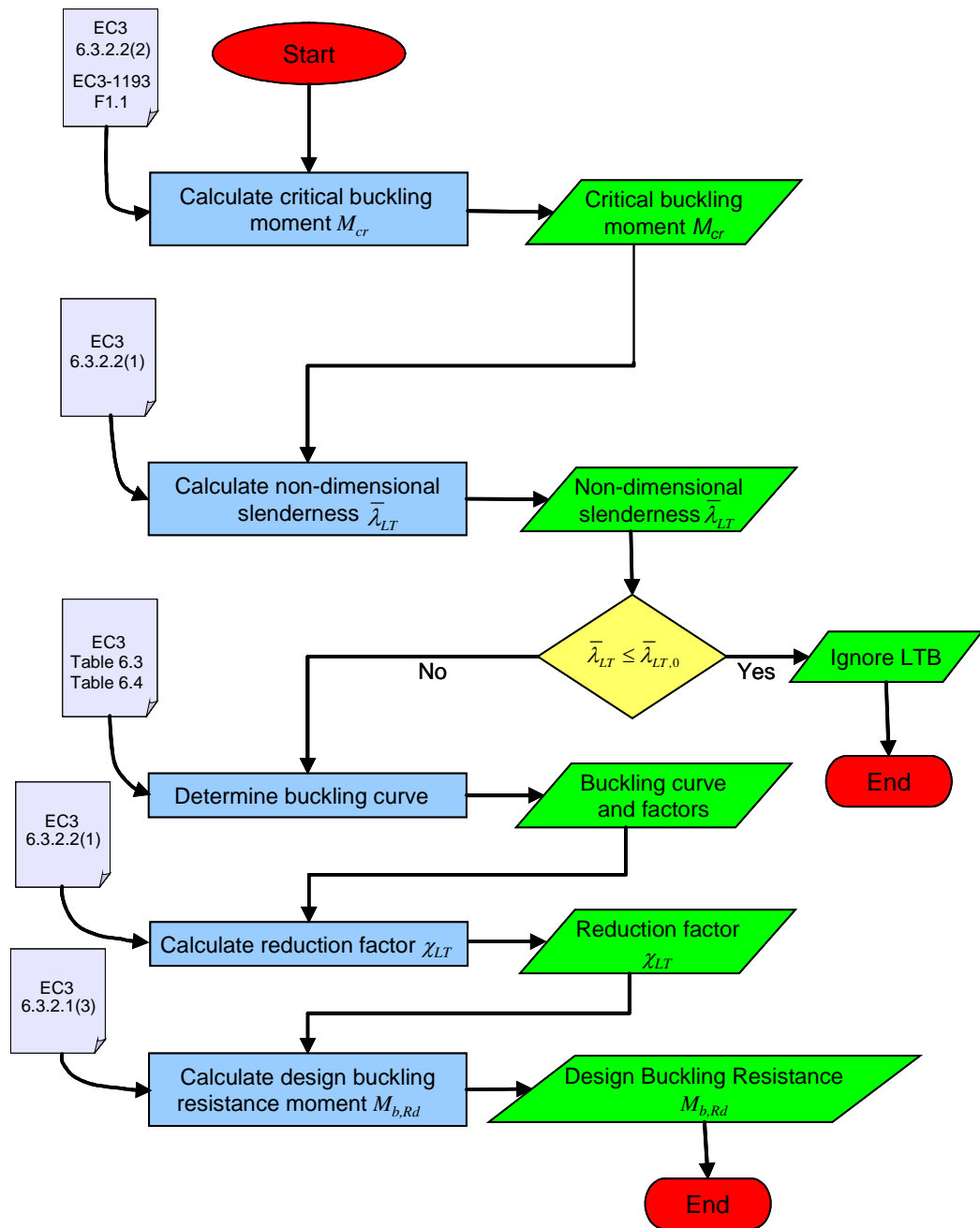

Figure 3-5: Design Buckling Resistance

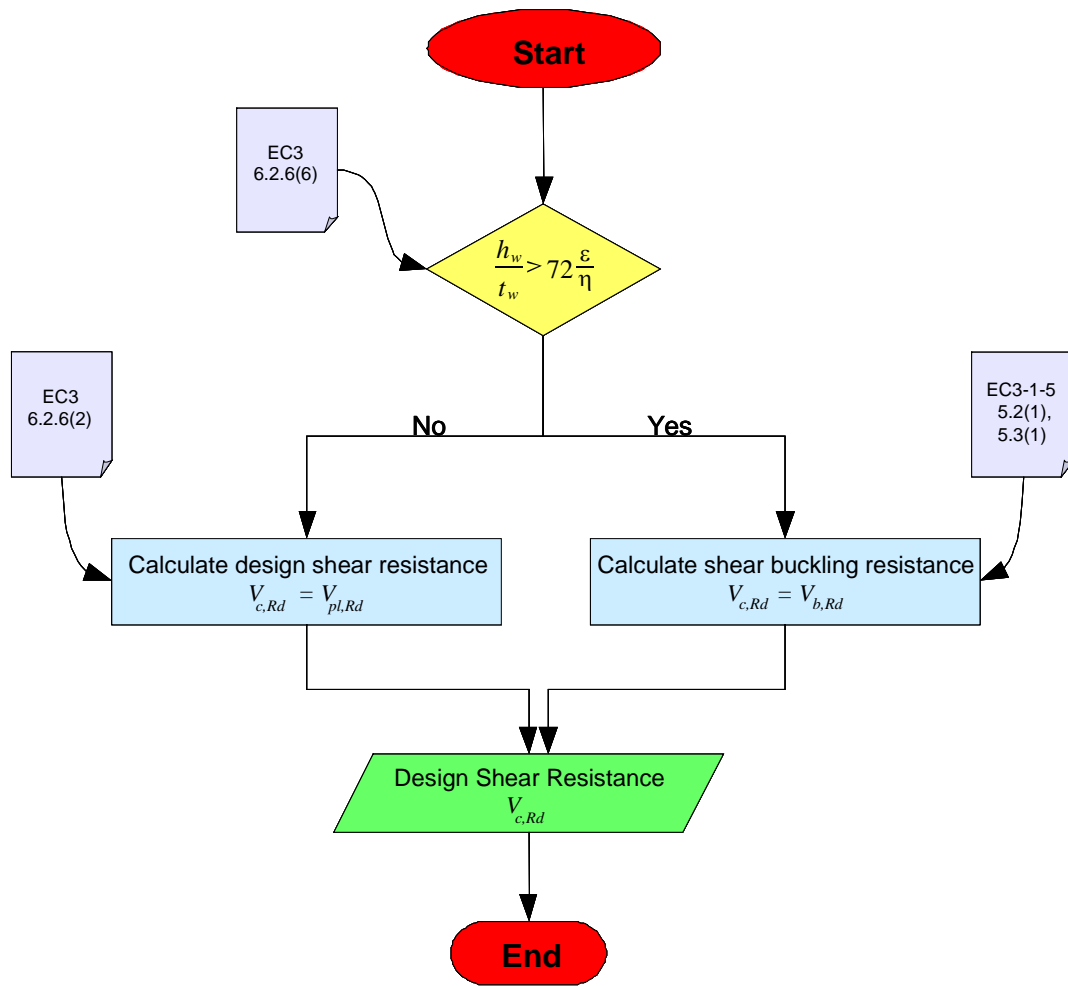

Figure 3-6: Design Shear Resistance

Chapter 4

General Design Parameters

This chapter provides a detailed description of the implementation of the various parameters used in the design algorithm for the “Eurocode 3-2005” steel frame design. These parameters are subsequently used in the following chapters for the design of sections for the applied force actions.

4.1 Partial Factors

The following partial factors, γ_M , are applied to the various characteristic resistance values determined in the following chapters. The partial factor values may be overwritten in the Design Preferences.

$$\gamma_{M0} = 1.00 \text{ [NDP]} \quad (\text{EC3 6.1(1)})$$

$$\gamma_{M1} = 1.00 \text{ [NDP]} \quad (\text{EC3 6.1(1)})$$

$$\gamma_{M2} = 1.25 \text{ [NDP]} \quad (\text{EC3 6.1(1)})$$

4.2 Design Forces

The following design force actions are considered in the design algorithm covered in the following chapters. The force actions are determined using the

appropriate load combinations described in the following section.

- Axial force (tension or compression), N_{Ed}
- Shear force (major or minor axis), V_{Ed}
- Bending moment (major or minor axis), M_{Ed}
- Torsion, T_{Ed}

It should be noticed that the torsion check is only limited to doubly-symmetric I-shapes, box shapes, and pipe shapes.

4.3 Design Load Combinations

The design load combinations are combinations of load cases for which the structure is designed and checked. A default set of automated load combinations is available in the software, as described in this section. These default combinations can be modified or deleted. In addition, manually defined combinations can be added should the default combinations not cover all conditions required for the structure of interest.

The default load combinations considered by the software for “Eurocode 3-2005”, are defined in the following sections and handle dead (D), live (L), wind (W), and earthquake (E) loads. For other load types, combinations should be manually generated.

The following two sections describe the automated load combinations generated by the software for ultimate strength and serviceability, in accordance with Eurocode 1990:2002 [EN 1990:2002].

4.3.1 Ultimate Strength Combinations

Eurocode 0:2002 allows load combinations to be defined based on EC0 equation 6.10 or the less favorable EC0 equations 6.10a and 6.10b [NDP].

$$\sum_{j \geq 1} \gamma_{G,j} G_{k,j} + \gamma_p P + \gamma_{Q,1} Q_{k,1} + \sum_{i > 1} \gamma_{Q,i} \psi_{0,i} Q_{k,i} \quad (\text{EC0 Eq. 6.10})$$

$$\sum_{j \geq 1} \gamma_{G,j} G_{k,j} + \gamma_p P + \gamma_{Q,1} \Psi_{Q,1} Q_{k,1} + \sum_{i > 1} \gamma_{Q,i} \Psi_{0,i} Q_{k,i} \quad (\text{EC0 Eq. 6.10a})$$

$$\sum_{j \geq 1} \xi_j \gamma_{G,j} G_{k,j} + \gamma_p P + \gamma_{Q,1} Q_{k,1} + \sum_{i > 1} \gamma_{Q,i} \Psi_{0,i} Q_{k,i} \quad (\text{EC0 Eq. 6.10b})$$

Load combinations including earthquake effects are generated based on:

$$\sum_{j \geq 1} G_{k,j} + P + A_{Ed} + \sum_{i > 1} \psi_{2,i} Q_{k,i} \quad (\text{EC0 Eq. 6.12b})$$

The following load combinations are considered if the option is set to generate the combinations based on EC0 equation 6.10.

$$\gamma_{Gj,\text{sup}} D \quad (\text{EC0 Eq. 6.10})$$

$$\gamma_{Gj,\text{sup}} D + \gamma_{Q,1} L \quad (\text{EC0 Eq. 6.10})$$

$$\gamma_{Gj,\text{inf}} D \pm \gamma_{Q,1} W \quad (\text{EC0 Eq. 6.10})$$

$$\gamma_{Gj,\text{sup}} D \pm \gamma_{Q,1} W$$

$$\gamma_{Gj,\text{sup}} D + \gamma_{Q,1} L \pm \gamma_{Q,i} \Psi_{0,i} W \quad (\text{EC0 Eq. 6.10})$$

$$\gamma_{Gj,\text{sup}} D \pm \gamma_{Q,1} W + \gamma_{Q,i} \Psi_{0,i} L$$

$$D \pm 1.0E \quad (\text{EC0 Eq. 6.12b})$$

$$D \pm 1.0E + \psi_{2,i} L$$

The following load combinations are considered if the option is set to generate the combinations based on the maximum of EC0 equations 6.10a and 6.10b.

$$\gamma_{Gj,\text{sup}} D \quad (\text{EC0 Eq. 6.10a})$$

$$\xi \gamma_{Gj,\text{sup}} D \quad (\text{EC0 Eq. 6.10b})$$

$$\gamma_{Gj,\text{sup}} D + \gamma_{Q,1} \Psi_{0,1} L \quad (\text{EC0 Eq. 6.10a})$$

$$\xi \gamma_{Gj,\text{sup}} D + \gamma_{Q,1} L \quad (\text{EC0 Eq. 6.10b})$$

$$\gamma_{Gj,\text{inf}} D \pm \gamma_{Q,1} \Psi_{0,1} W \quad (\text{EC0 Eq. 6.10a})$$

$$\gamma_{Gj,\text{sup}} D \pm \gamma_{Q,1} \Psi_{0,1} W$$

$$\gamma_{Gj,\text{inf}} D \pm \gamma_{Q,1} W \quad (\text{EC0 Eq. 6.10b})$$

$$\xi \gamma_{Gj,\text{sup}} D \pm \gamma_{Q,1} W$$

$$\gamma_{Gj,\text{sup}} D + \gamma_{Q,1} \Psi_{0,1} L \pm \gamma_{Q,i} \Psi_{0,i} W \quad (\text{EC0 Eq. 6.10a})$$

$$\gamma_{Gj,\text{sup}} D \pm \gamma_{Q,1} \psi_{0,1} W + \gamma_{Q,i} \psi_{0,i} L \quad (\text{EC0 Eq. 6.10b})$$

$$\xi \gamma_{Gj,\text{sup}} D + \gamma_{Q,1} L \pm \gamma_{Q,i} \psi_{0,i} W$$

$$\xi \gamma_{Gj,\text{sup}} D \pm \gamma_{Q,1} W + \gamma_{Q,i} \psi_{0,i} L$$

$$D \pm 1.0E$$

$$D \pm 1.0E + \psi_{2,\square} L \quad (\text{EC0 Eq. 6.12b})$$

The variable values and factors used in the load combinations are defined as:

$$\gamma_{Gj,\text{sup}} = 1.35 \text{ [NDP]} \quad (\text{EC0 Table A1.2(B)})$$

$$\gamma_{Gj,\text{inf}} = 1.00 \text{ [NDP]} \quad (\text{EC0 Table A1.2(B)})$$

$$\gamma_{Q,1} = 1.5 \text{ [NDP]} \quad (\text{EC0 Table A1.2(B)})$$

$$\psi_{0,i} = \begin{cases} 0.7 & \text{(live load, not storage)} \\ 0.6 & \text{(wind load)} \end{cases} \text{ [NDP]} \quad (\text{EC0 Table A1.1})$$

$$\xi = 0.85 \text{ [NDP]} \quad (\text{EC0 Table A1.2(B)})$$

$$\psi_{2,i} = 0.3 \text{ (assumed office/residential) [NDP]} \quad (\text{EC0 Table A1.1})$$

4.3.2 Serviceability Combinations

The following characteristic load combinations are considered for the deflection checks.

$$D \quad (\text{EC0 Eq. 6.10a})$$

$$D + L \quad (\text{EC0 Eq. 6.10a})$$

4.4 Material Properties

The nominal values of the yield strength f_y and ultimate strength f_u are used in the design. The design assumes that the input material properties conform to the steel grades listed in the code (EC3 Table 3.1) or have been verified using other methods, to be adequate for use with “Eurocode 3-2005.”

The design values of material coefficients (EC3 3.2.6) are taken from the input material properties, rather than directly from the code.

4.5 Section Classification

“Eurocode 3-2005” classifies sections into four different classes, which identify the extent to which the resistance and rotation capacity is limited by local buckling. The different classes are based on the width-to-thickness ratio of the parts subject to compression and are defined as:

- Class 1 – section can form a plastic hinge with the rotation capacity required from plastic analysis, without reduction of the resistance.
- Class 2 – section can develop its plastic moment capacity, but has limited rotation capacity.
- Class 3 – section in which the stress in the extreme compression fiber of the section, assuming an elastic distribution of stresses, can reach the yield strength, but local buckling is likely to prevent the development of the plastic moment capacity.
- Class 4 – section is subject to local buckling before reaching the yield stress in one or more of the parts.
- Too Slender – section does not satisfy any of the criteria for Class 1, 2, 3, or 4. This happens when $t_f < 3$ mm or $t_w < 3$ mm. Too Slender sections are beyond the scope of the code. They are not checked/designed.

The following three tables identify the limiting width-to-thickness ratios for classifying the various parts of the cross-section, subject to bending only, compression only, or combined bending and compression.

The various parameters used in calculating the width-to-thickness ratio limits are defined as:

$$\varepsilon = \sqrt{235/f_y} \quad (\text{EC3 Table 5.2})$$

$$\psi = -\left(1 + 2 \frac{N_{Ed}}{Af_y}\right), \quad -3.0 < \psi \leq 1.0 \quad (\text{EC3 5.5.2, Table 5.2})$$

- for I-sections, Channels:

$$\alpha = \frac{1}{c} \left[\frac{h}{2} - \frac{1}{2} \frac{N_{Ed}}{t_w f_y} - (t_f - r) \right], \quad -1 \leq \alpha \leq 1 \quad (\text{EC3 5.5.2, Table 5.2})$$

- for Boxes and Double Channel sections

$$\alpha = \frac{1}{c} \left[\frac{h}{2} - \frac{1}{4} \frac{N_{Ed}}{t_w f_y} - (t_f + r) \right], \quad -1 \leq \alpha \leq 1 \quad (\text{EC3 5.5.2, Table 5.2})$$

Table 4-1: Width-To-Thickness Ratios - Bending Only

Shape	Part	Ratio	Class 1	Class 2	Class 3
I-sections, Channels	Web	c/t	72ε	83ε	124ε
	Web	c/t	If tip is in comp. $9\varepsilon/\alpha$	If tip is in comp. $10\varepsilon/\alpha$	$21\varepsilon\sqrt{k_\sigma}$
Tees			If tip is in tension, $\frac{9\varepsilon}{\alpha\sqrt{\alpha}}$	If tip is in tension, $\frac{10\varepsilon}{\alpha\sqrt{\alpha}}$	
	Flange	c/t	9ε	10ε	14ε
Boxes	Web, flange	c/t	72ε	83ε	124ε
Tubes/Pipes	Wall	d/t	$50\varepsilon^2$	$70\varepsilon^2$	$90\varepsilon^2$
Solid Bars	Bar	N/A	Assumed to be Class 2		
General, Section Designer	Section	N/A	Assumed to be Class 3		

Table 4-2: Width-To-Thickness Ratios - Compression Only

Shape	Part	Ratio	Class 1	Class 2	Class 3
I-sections, Channels	Web	c/t	33ε	38ε	42ε
	Flange	c/t	9ε	10ε	14ε
Tees	Web, flange	c/t	9ε	10ε	14ε
Angles, Double Angles	Legs	h/t and $(b+h)/2t$	N/A	N/A	15ε and 11.5ε
Boxes	Web, flange	c/t	33ε	38ε	42ε
Tubes/Pipes	Wall	d/t	$50\varepsilon^2$	$70\varepsilon^2$	$90\varepsilon^2$
Solid Bars	Bar	N/A	Assumed to be Class 2		
General, Section Designer	Section	N/A	Assumed to be Class 3		

Table 4-3: Width-To-Thickness Ratios – Combined Bending And Compression

Shape	Part	Ratio	Class 1	Class 2	Class 3
I-sections, Channels	Web	c/t	$396\varepsilon/(13\alpha - 1)$ when $\alpha > 0.5$; $36\varepsilon/\alpha$ when $\alpha \leq 0.5$	$456\varepsilon/(13\alpha - 1)$ when $\alpha > 0.5$; $41.5\varepsilon/\alpha$ when $\alpha \leq 0.5$	$42\varepsilon/(0.67 + 0.33\psi)$ when $\psi > -1$; $62\varepsilon(1-\psi)\sqrt{-\psi}$ when $\psi \leq -1$
	Flange (tip in comp.)	c/t	$9\varepsilon/\alpha$	$10\varepsilon/\alpha$	$21\varepsilon\sqrt{k_\sigma}$
	Flange (tip in tens.)	c/t	$9\varepsilon/(\alpha\sqrt{\alpha})$	$10\varepsilon/(\alpha\sqrt{\alpha})$	
Tees	Web	c/t	If tip is in comp. $9\varepsilon/\alpha$ If tip is in tension, $\frac{9\varepsilon}{\alpha\sqrt{\alpha}}$	If tip is in comp. $10\varepsilon/\alpha$ If tip is in tension, $\frac{10\varepsilon}{\alpha\sqrt{\alpha}}$	$21\varepsilon\sqrt{k_\sigma}$
	Flange	c/t	9ε	10ε	14ε
Boxes	Web, flange	c/t	$396\varepsilon/(13\alpha - 1)$ when $\alpha > 0.5$; $36\varepsilon/\alpha$ when $\alpha \leq 0.5$	$456\varepsilon/(13\alpha - 1)$ when $\alpha > 0.5$; $41.5\varepsilon/\alpha$ when $\alpha \leq 0.5$	$42\varepsilon/(0.67 + 0.33\psi)$ when $\psi > -1$; $62\varepsilon(1-\psi)\sqrt{-\psi}$ when $\psi \leq -1$
Tubes/Pipes	Wall	d/t	$50\varepsilon^2$	$70\varepsilon^2$	$90\varepsilon^2$
Solid Bars	Bar	N/A		Assumed to be Class 2	
General, Section Designer	Section	N/A		Assumed to be Class 3	

Chapter 5

Design for Axial Force

This chapter provides a detailed description of the design algorithm for the “Eurocode 3-2005” steel frame design, with respect to designing for axial forces. The following topics are covered:

- calculation of axial area (EC3 6.2.2)
- design for axial tension (EC3 6.2.3)
- design for axial compression (EC3 6.2.4)
- design for axial buckling (EC3 6.3.1)

5.1 Axial Area

The gross cross-section area, A , is based on nominal dimensions, ignoring fastener holes and splice materials, and accounting for larger openings.

The net cross-section area, A_{net} , is defined as the gross cross-section area, A , minus fastener holes and other openings. By default, A_{net} is taken equal to A . This value can be overwritten on a member-by-member basis using the *Net Area to Total Area Ratio* overwrite.

5.2 Tension Check

The axial tension check at each output station shall satisfy:

$$\frac{N_{Ed}}{N_{t,Rd}} \leq 1.0 \quad (\text{EC3 6.2.3(1)})$$

where the design tension resistance, $N_{t,Rd}$ is taken as the smaller of:

- the design plastic resistance, $N_{pl,Rd}$ of the gross cross-section

$$N_{pl,Rd} = \frac{Af_y}{\gamma_{M0}} \quad (\text{EC3 6.2.3(2)a})$$

- the design ultimate resistance, $N_{u,Rd}$ of the net cross-section

$$N_{u,Rd} = \frac{0.9A_{net}f_u}{\gamma_{M2}} \quad (\text{EC3 6.2.3(2)b})$$

The values of A and A_{net} are defined in Section 5.1.

5.3 Compression Check

The axial compression check at each output station shall satisfy:

$$\frac{N_{Ed}}{N_{c,Rd}} \leq 1.0 \quad (\text{EC3 6.2.4(1)})$$

where the design compression resistance, $N_{c,Rd}$ for Class 1, 2, 3, and 4 sections is taken as:

$$N_{c,Rd} = \frac{Af_y}{\gamma_{M0}} \quad \text{for Class 1, 2, or 3 cross-sections} \quad (\text{EC3 6.2.4(2)})$$

$$N_{c,Rd} = \frac{A_{eff}f_y}{\gamma_{M0}} \quad \text{for Class 4 cross-sections} \quad (\text{EC3 6.2.4(2)})$$

The value of A is defined in Section 5.1 of this manual. A_{eff} is the effective area of the cross-section when subjected to uniform compression. A_{eff} is based on the effective widths of the compression parts (EC3 6.2.9.3(2), 6.2.2.5(1)). It is determined based on the EN 1993-1-5 code (EN 1993-1-5 4.4(2), Table 4.1, Table 4.2).

5.4 Axial Buckling Check

The axial buckling check at each output station shall satisfy:

$$\frac{N_{Ed}}{N_{b,Rd}} \leq 1.0 \quad (\text{EC3 6.3.1.1(1)})$$

where the design compression resistance, $N_{b,Rd}$ for Class 1, 2, 3, and 4 sections is taken as:

$$N_{b,Rd} = \frac{\chi A f_y}{\gamma_{MI}} \quad \text{for Class 1, 2, and 3 cross-sections} \quad (\text{EC3 6.3.1.1(3)})$$

$$N_{b,Rd} = \frac{\chi A_{eff} f_y}{\gamma_{MI}} \quad \text{for Class 4 cross-sections} \quad (\text{EC3 6.3.1.1(3)})$$

The reduction factor, χ for the relevant buckling mode is taken as:

$$\chi = \frac{1}{\Phi + \sqrt{\Phi^2 - \bar{\lambda}^2}} \leq 1.0 \quad (\text{EC3 6.3.1.2(1)})$$

where the factor, Φ and the non-dimensional slenderness, $\bar{\lambda}$ are taken as:

$$\Phi = 0.5 \left[1 + \alpha (\bar{\lambda} - 0.2) + \bar{\lambda}^2 \right] \quad (\text{EC3 6.3.1.2(1)})$$

$$\bar{\lambda} = \sqrt{\frac{A f_y}{N_{cr}}} = \frac{L_{cr}}{i} \frac{1}{\lambda_1}, \quad \text{for Class 1, 2 and 3 cross-sections} \quad (\text{EC3 6.3.1.3(1)})$$

$$\bar{\lambda} = \sqrt{\frac{A_{eff} f_y}{N_{cr}}} = \frac{L_{cr}}{i} \frac{\sqrt{A_{eff}/A}}{\lambda}, \quad \text{for Class 4 cross-sections} \quad (\text{EC3 6.3.1.2(1)})$$

$$\lambda_1 = \pi \sqrt{\frac{E}{f_y}} \quad (\text{EC3 6.3.1.3(1)})$$

The elastic critical force, N_{cr} is based on gross cross-section properties.

The value of A is defined in Section 5.1. The imperfection factor, α is defined in Table 5.1 based on the respective buckling curve, defined in Table 5.2 of this manual. The value L_{cr} is the effective unbraced length and i is the radius of gyration about the relevant axis. L_{cr} is taken as follows:

$$L_{cr} = KL$$

where K is the effective length factor for flexural buckling. It can assume two values: K_{22} for buckling about the minor axis (z-z) and K_{33} for buckling about the major axis (y-y). L is the unbraced length of the member. It also can assume two values, L_{22} and L_{33} , for buckling about minor axis (z-z) and major axis (y-y), respectively. See Sections 5.5 and 5.6 of this manual for more details on L and K .

For all sections except Single Angles, the principal radii of gyration i_{22} and i_{33} are used. For Single Angles, the minimum (principal) radius of gyration, i_z , is used instead of i_{22} and i_{33} , conservatively, in computing L_{cr}/i . K_{33} and K_{22} are two values of K_2 for the major and minor axes of bending. K_2 is the effective length factor for actual (sway or nonsway) conditions.

The axial buckling check is not ignored if:

$$\bar{\lambda} \leq 0.2 \text{ or } \frac{N_{Ed}}{N_{cr}} \leq 0.04 \quad (\text{EC3 6.3.1.2(4)})$$

Table 5-1: Imperfection Factors (EC3 6.3.1.2(2), Table 6.1)

Buckling Curve	a ₀	a	b	c	d
Imperfection Factor, α	0.13	0.21	0.34	0.49	0.76

Table 5-2: Buckling Curves (EC3 6.3.1.2(2), Table 6.2)

Section Shape	Limits		Axis	Buckling Curve	
				S235, S275, S355, S420	S460
Rolled I-sections	$h/b > 1.2$	$t_f \leq 40$ mm	Major Minor	a b	a ₀ a ₀
		$40 < t_f \leq 100$ mm	Major Minor	b c	a a
	$h/b \leq 1.2$	$t_f \leq 100$ mm	Major Minor	b c	a a
		$t_f > 100$ mm	Major Minor	d d	c c
Welded I-sections	$t_f \leq 40$ mm		Major Minor	b c	b c
	$t_f > 40$ mm		Major Minor	c d	c d
Hollow Tube and Pipe Sections	hot finished		any	a	a ₀
Welded Box	$b/t_f > 30$ or $h/t_w > 30$		any	b	b
	$b/t_f < 30$ or $h/t_w < 30$		any	c	c
Channel, Tee, Double Channel, General, Solid Sections, Section Designer	none		any	c	c
Angle and Double Angle Sections	none		any	b	b

5.5 Member Unsupported Lengths

The column unsupported lengths are required to account for column slenderness effects for flexural buckling and for lateral-torsional buckling. The program automatically determines the unsupported length ratios, which are specified as a fraction of the frame object length. Those ratios times the frame object lengths give the unbraced lengths for the member. Those ratios also can be overwritten by the user on a member-by-member basis, if desired, using the design overwrite option.

Two unsupported lengths, L_{33} and L_{22} , as shown in Figure 5-1 are to be considered for flexural buckling. These are the lengths between support points of the member in the corresponding directions. The length L_{33} corresponds to instability about the 3-3 axis (major axis), and L_{22} corresponds to instability about the 2-2 axis (minor axis). The length L_{LTB} , not shown in the figure, is also used for lateral-torsional buckling caused by major direction bending (i.e., about the 3-3 axis).

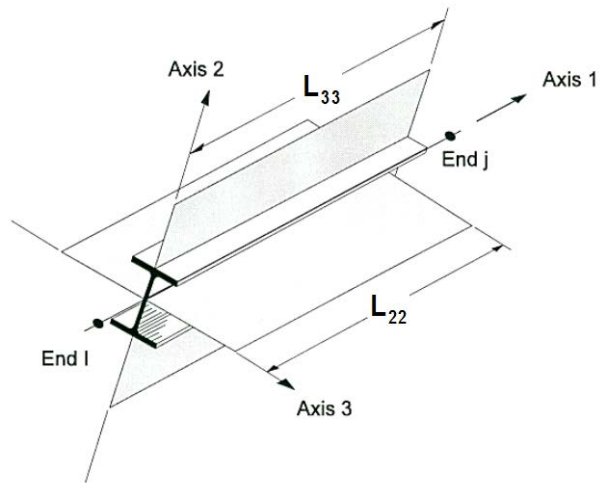

Figure 5-1 Unsupported lengths L_{33} and L_{22}

In determining the values for L_{22} and L_{33} of the members, the program recognizes various aspects of the structure that have an effect on these lengths, such as member connectivity, diaphragm constraints, and support points. The program automatically locates the member support points and evaluates the corresponding unsupported length.

It is possible for the unsupported length of a frame object to be evaluated by the program as greater than the corresponding member length. For example, assume a column has a beam framing into it in one direction, but not the other, at a floor level. In that case, the column is assumed to be supported in one direction only at that story level, and its unsupported length in the other direction will exceed the story height.

By default, the unsupported length for lateral-torsional buckling, L_{LTB} , is taken to be equal to the L_{22} factor. Similar to L_{22} and L_{33} , L_{LTB} can be overwritten.

The unsupported length for minor direction bending for lateral-torsional buckling also can be defined more precisely by using “precise” bracing points in the Lateral Bracing option, which is accessed using the **Design > Lateral Bracing** command. This allows the user to define the lateral bracing of the top, bottom, or both flanges. The bracing can be a point brace or continuous bracing.

The program calculates the unbraced length to determine axial capacity based on the limit state of flexural buckling from this definition. Any bracing at the top or bottom, or both, is considered enough for flexural buckling in the minor direction. While checking moment capacity for the limit state of lateral-torsional buckling (LTB) at a station, the program dynamically calculates the bracing points on the compression flange at the left and at the right of the check station considering the sign of moment diagram. This definition affects only the unbraced lengths for minor direction bending (L_{22}) and lateral-torsional buckling (L_{LTB}). This “exact” method of bracing definition does not allow the user to define unbraced lengths for major direction bending (L_{33}).

There are three sources of unbraced length ratio: (1) “automatic” calculation, (2) “precise” bracing definition, (3) overwrites, with increasing priority in considerations. “Automatic” calculation of the unbraced length is based on member connectivity considering only the members that have been entered into the model. This misses the tiny bracing members. However, such automatically calculated bracing lengths are load combo (moment diagram) independent. This can be reported easily. Similarly, the overwritten values are load combo independent. This allows the program to report the overwritten unbraced length easily. However, if the member has a “precise” bracing definition, the unbraced length can be different at different stations of the member along the length. Also it can be load combo dependent. Thus, when the unbraced length is reported in the detailed design info, it is reported perfectly considering all three sources as needed. However, when reporting unbraced length on the model shown in the active window, the program-reported value comes from “automatic” calculation or from the overwrites if the user has overwritten it.

5.6 Effective Length Factor (K)

The effective length method for calculating member axial compressive strength has been used in various forms in several stability based design codes. The method originates from calculating effective buckling lengths, KL , and is based on elastic/inelastic stability theory. The effective buckling length is used to calculate an axial compressive strength, $N_{b,Rd}$, through an empirical column curve that accounts for geometric imperfections, distributed yielding, and residual stresses present in the cross-section.

There are two types of K -factors in the “Eurocode 3-2005” code. The first type of K -factor is used for calculating the Euler axial capacity assuming that all of the member joints are held in place, i.e., no lateral translation is allowed. The resulting axial capacity is used in calculation of the k factors. This K -factor is named as K_1 in this document. The program calculates the K_1 factor automatically based on nonsway condition. This K_1 factor is always less than 1. The program allows the user to overwrite K_1 on a member-by-member basis.

The other K -factor is used for calculating the Euler axial capacity assuming that all the member joints are free to sway, i.e., lateral translation is allowed. The resulting axial capacity is used in calculating $N_{b,Rd}$. This K -factor is named as K_2 in this document. This K_2 is always greater than 1 if the frame is a sway frame. The program calculates the K_2 factor automatically based on sway condition. The program also allows the user to overwrite K_2 factors on a member-by-member basis. If the frame is not really a sway frame, the user should overwrite the K_2 factors.

Both K_1 and K_2 have two values: one for major direction and the other for minor direction, $K_{1\text{minor}}$, $K_{1\text{major}}$, $K_{2\text{minor}}$, $K_{2\text{major}}$.

There is another K -factor. K_{ltb} for lateral-torsional buckling. By default, K_{ltb} is taken as equal to $K_{2\text{minor}}$. However, the user can overwrite this on a member-by-member basis.

Determination K_2 Factors:

The K -factor algorithm has been developed for building-type structures, where the columns are vertical and the beams are horizontal, and the behavior is basically that of a moment-resisting frame for which the K -factor calculation is

relatively complex. For the purpose of calculating K -factors, the objects are identified as columns, beams, and braces. All frame objects parallel to the Z -axis are classified as columns. All objects parallel to the X - Y plane are classified as beams. The remainders are considered to be braces.

The beams and braces are assigned K -factors of unity. In the calculation of the K -factors for a column object, the program first makes the following four stiffness summations for each joint in the structural model:

$$S_{cx} = \sum \left(\frac{E_c I_c}{L_c} \right)_x \qquad S_{bx} = \sum \left(\frac{E_b I_b}{L_b} \right)_x$$

$$S_{cy} = \sum \left(\frac{E_c I_c}{L_c} \right)_y \qquad S_{by} = \sum \left(\frac{E_b I_b}{L_b} \right)_y$$

where the x and y subscripts correspond to the global X and Y directions and the c and b subscripts refer to column and beam. The local 2-2 and 3-3 terms EI_{22}/L_{22} and EI_{33}/L_{33} are rotated to give components along the global X and Y directions to form the $(EI/L)_x$ and $(EI/L)_y$ values. Then for each column, the joint summations at END-I and the END-J of the member are transformed back to the column local 1-2-3 coordinate system, and the G -values for END-I and the END-J of the member are calculated about the 2-2 and 3-3 directions as follows:

$$G^I_{22} = \frac{S^I_{c22}}{S^I_{b22}} \qquad G^J_{22} = \frac{S^J_{c22}}{S^J_{b22}}$$

$$G^I_{33} = \frac{S^I_{c33}}{S^I_{b33}} \qquad G^J_{33} = \frac{S^J_{c33}}{S^J_{b33}}$$

If a rotational release exists at a particular end (and direction) of an object, the corresponding value of G is set to 10.0. If all degrees of freedom for a particular joint are deleted, the G -values for all members connecting to that joint will be set to 1.0 for the end of the member connecting to that joint. Finally, if G^I and G^J are known for a particular direction, the column K_2 -factor for the corresponding direction is calculated by solving the following relationship for α :

$$\frac{\alpha^2 G^I G^J - 36}{6(G^I + G^J)} = \frac{\alpha}{\tan \alpha} \quad (\text{sway})$$

from which $K_2 = \pi/\alpha$. This relationship is the mathematical formulation for the evaluation of K -factors for moment-resisting frames assuming sidesway to be uninhibited. For other structures, such as braced frame structures, the K -factors for all members are usually unity and should be set so by the user. The following are some important aspects associated with the column K -factor algorithm:

- An object that has a pin at the joint under consideration will not enter the stiffness summations calculated previously. An object that has a pin at the far end from the joint under consideration will contribute only 50% of the calculated EI value. Also, beam members that have no column member at the far end from the joint under consideration, such as cantilevers, will not enter the stiffness summation.
- If there are no beams framing into a particular direction of a column member, the associated G -value will be infinity. If the G -value at any one end of a column for a particular direction is infinity, the K -factor corresponding to that direction is set equal to unity.
- If rotational releases exist at both ends of an object for a particular direction, the corresponding K -factor is set to unity.
- The automated K -factor calculation procedure occasionally can generate artificially high K -factors, specifically under circumstances involving skewed beams, fixed support conditions, and under other conditions where the program may have difficulty recognizing that the members are laterally supported and K -factors of unity are to be used.
- All K -factor produced by the program can be overwritten by the user. These values should be reviewed and any unacceptable values should be replaced.
- The beams and braces are assigned K -factors of unity.

Determination K_1 Factors:

If G^I and G^J are known for a particular direction, the column K_1 -factor for the corresponding direction is calculated by solving the following relationship for

α :

$$\frac{G^I G^J}{4} \alpha^2 + \left(\frac{G^I + G^J}{2} \right) \left(1 - \frac{\alpha}{\tan \alpha} \right) + \left(\frac{\tan(\alpha/2)}{(\alpha/2)} - 1 \right) = 0 \quad (\text{non-sway})$$

from which $K_1 = \pi/\alpha$. This relationship is the mathematical formulation for the evaluation of K_1 -factor for moment-resisting frames assuming sidesway to be inhibited. The calculation of G^I and G^J follows the same procedure as that for K_2 -factor which is already described in this section.

Chapter 6

Design for Bending Moment

This chapter provides a detailed description of the design algorithm for the “Eurocode 3-2005” steel frame design when designing for bending moments. The following topics are covered:

- design for bending moment (EC3 6.2.5)
- design for lateral-torsional buckling (EC3 6.3.2)

6.1 Moment Check

The moment check at each output station shall satisfy:

$$\frac{M_{Ed}}{M_{c,Rd}} \leq 1.0 \quad (\text{EC3 6.2.5(1)})$$

where the design moment resistance, $M_{c,Rd}$ is taken as:

- Class 1 or 2 sections

$$M_{c,Rd} = M_{pl,Rd} = \frac{W_{pl} f_y}{\gamma_{M0}} \quad (\text{EC3 6.2.5(2)})$$

- Class 3 sections

$$M_{c,Rd} = M_{el,Rd} = \frac{W_{el,min} f_y}{\gamma_{M0}} \quad (\text{EC3 6.2.5(2)})$$

Class 4 sections:

$$M_{c,Rd} = \frac{W_{eff,min} f_y}{\gamma_{M0}} \quad (\text{EC3 6.2.5(2)})$$

The plastic and elastic section modulus values, W_{pl} and $W_{el,min}$ are part of the frame section definition.

$W_{eff,min}$ is the effective section modulus, corresponding to the fiber with the maximum elastic stress, of the cross-section when subjected only to moment about the relevant axis. $W_{eff,min}$ is based on the effective widths of the compression parts (EC3 6.2.9.3(2), 6.2.2.5(1)). It is determined based on EN 1993-1-5 code (EN 1993-1-5 4.4(2), Table 4.1, Table 4.2).

The effect of high shear on the design moment resistance, $M_{c,Rd}$ is considered if:

$$V_{Ed} \geq 0.5V_{pl,Rd} \quad (\text{EC3 6.2.8(2)})$$

To account for the effect of high shear in I-sections, Channels, Double Channels, Rectangular Hollow Sections, Tee and Double Angle sections subjected to major axis moment, the reduced design plastic resistance moment is taken as:

$$M_{y,v,Rd} = \frac{\left[W_{pl,y} - \frac{n\rho A_w^2}{4t_w} \right] f_y}{\gamma_{M0}} \leq M_{y,c,Rd} \quad (\text{EC3 6.2.8(5)})$$

where n , ρ and A_w are taken as:

$$n = \begin{cases} 1 & \text{for I, Channel, and Tee sections} \\ 2 & \text{for Double Channel, Hollow Rectangular, and} \\ & \text{Double Angle sections} \end{cases} \quad (\text{EC3 6.2.8(5)})$$

$$\rho = \left(\frac{2V_{Ed}}{V_{pl,Rd}} - 1 \right)^2 \quad (\text{EC3 6.2.8(3)})$$

$$A_w = h_w t_w \quad (\text{EC3 6.2.8(5)})$$

For all other sections, including Hollow Pipe, Solid Rectangular, Circular, and Angle sections, the reduced design plastic resistance moment is taken as:

$$M_{y,V,Rd} = (1 - \rho) M_{c,Rd} \quad (\text{EC3 6.2.8(3)})$$

Similarly, for I, Channel, Double Channel, Rectangular Hollow, Tee and Double Angle sections, if the minor direction shear is more than 0.5 times the plastic shear resistance in the minor direction, the corresponding plastic resistance moment is also reduced as follows:

$$M_{z,V,Rd} = \frac{\left[W_{pl,z} - \frac{n \rho A_f^2}{4 t_f} \right] f_y}{\gamma_{M0}} \leq M_{z,c,Rd} \quad (\text{EC3 6.2.8(5)})$$

where,

$$n = \begin{cases} 1, & \text{for Tee sections,} \\ 2, & \text{for I, Channel, Double Angle,} \\ & \text{Hollow Rectangular sections, and} \\ 4, & \text{for Double Channel sections.} \end{cases} \quad (\text{EC3 6.2.8(5)})$$

$$\rho = \left(\frac{2V_{y,Ed}}{V_{y,pl,Rd}} - 1 \right)^2 \quad (\text{EC3 6.2.8(3)})$$

$$A_f = b_f t_f \quad (\text{EC3 6.2.8(5)})$$

For all other sections, the reduced design plastic resistance moment is taken as:

$$M_{z,V,Rd} = (1 - \rho) M_{z,c,Rd} \quad (\text{EC3 6.2.8(3)})$$

6.2 Lateral-Torsional Buckling Check

The lateral-torsional buckling check at each output station shall satisfy:

$$\frac{M_{Ed}}{M_{b,Rd}} \leq 1.0 \quad (\text{EC3 6.3.2.1(1)})$$

where the design buckling resistance moment, $M_{b,Rd}$ is taken as:

$$M_{b,Rd} = \chi_{LT} W_y \frac{f_y}{\lambda_{MI}} \quad (\text{EC3 6.3.2.1(3)})$$

and the section modulus, W_y is defined based on the section classification:

– Class 1 or 2 sections

$$W_y = W_{pl,y} \quad (\text{EC3 6.3.2.1(3)})$$

– Class 3 sections

$$W_y = W_{el,y} \quad (\text{EC3 6.3.2.1(3)})$$

– Class 4 sections

$$W_y = W_{eff,y} \quad (\text{EC3 6.3.2.1(3)})$$

W_{pl} , W_{el} , and W_{eff} have been described in the previous section.

The reduction factor χ_{LT} is taken as:

$$\chi_{LT} = \frac{1}{\Phi_{LT} + \sqrt{\Phi_{LT}^2 - \bar{\lambda}_{LT}^2}} \leq 1.0 \quad (\text{EC3 6.3.2.2(1)})$$

where the factor, Φ , and the non-dimensional slenderness, $\bar{\lambda}_{LT}$ are taken as:

$$\Phi_{LT} = 0.5 \left[1 + \alpha_{LT} (\bar{\lambda}_{LT} - 0.2) + \bar{\lambda}_{LT}^2 \right] \quad (\text{EC3 6.3.2.2(1)})$$

$$\bar{\lambda}_{LT} = \sqrt{\frac{W_y f_y}{M_{cr}}} \quad (\text{EC3 6.3.2.2(1)})$$

The elastic critical moment, M_{cr} is based on gross cross-section properties and taken as:

$$M_{cr} = C_1 \frac{\pi^2 EI_z}{L_{cr}^2} \left(\frac{I_w}{I_z} + \frac{L_{cr}^2 GI_T}{\pi^2 EI_z} \right)^{0.5} \quad (\text{EC3-1993 F1.1})$$

where I_z , I_w , and I_T are the minor axis inertia, warping constant, and torsion constant, respectively; L_{cr} is the effective unbraced length for the lateral-torsional buckling mode, and C_1 is defined as:

$$C_1 = 1.88 - 1.40\psi + 0.52\psi^2 \leq 2.7 \quad (\text{EC3-1993 F1.1(6)})$$

where ψ is the ratio of the smaller to the larger end moments. The value of C_1 is also taken as 1.0 if the unbraced length is overwritten. The value of C_1 can be overwritten on a member-by-member basis.

When determining the nominal flexural strength about the major principal axis for any sections for the limit state of lateral-torsional buckling, it is common to use the term C_1 , the lateral-torsional buckling modification factor for non-uniform moment diagram. C_1 is calculated as follows:

$$C_1 = \frac{12.5M_{\max}}{2.5M_{\max} + 3M_A + 4M_B + 3M_C} \leq 2.7$$

where,

M_{\max} = absolute value of maximum moment in unbraced segment, N-mm.

M_A = absolute value of moment at quarter point of the unbraced segment, N-mm.

M_B = absolute value of moment at centerline of the unbraced segment, N-mm.

M_C = absolute value of moment at three-quarter point of the unbraced segment, N-mm.

C_1 should be taken as 1.0 for cantilevers. However, the program is unable to detect whether the member is a cantilever. **The user should overwrite C_1 for cantilevers.** The program also defaults C_1 to 1.0 if the minor unbraced length, l_{22} , is redefined to be more than the length of the member by the user or the program, i.e., if the unbraced length is longer than the member length. The Overwrites can be used to change the value of C_1 for any member.

Here, L_{cr} is the effective unbraced length for the lateral-torsional buckling mode.

$$L_{cr} = K_{LTB} L_{LTB}$$

when K_{LTB} is the effective length factor for the lateral-torsional buckling mode, and L_{LTB} is the unbraced length for the lateral-torsional buckling mode. For more details on these two factors, please refer to Sections 5.5 and 5.6 in Chapter 5 of this manual.

The imperfection factor, α_{LT} is defined in Table 6-1 based on the respective buckling curve, defined in Table 6-2 (EC3 6.3.2.2(2)).

Table 6-1: Imperfection factors (EC3 Table 6.3, 6.3.2.2(2))

Buckling Curve	a	b	c	d
Imperfection Factor, $\alpha_{LT}[NDP]$	0.21	0.34	0.49	0.76

Table 6-2: Buckling curves (EC3 Table 6.4, 6.3.2.2(2))

Section Shape	Limits	Buckling Curve
Rolled I-sections	$h/b \leq 2$	a
	$h/b > 2$	b
Welded I-sections	$h/b \leq 2$	c
	$h/b > 2$	d
Other sections	-	d

The lateral-torsional buckling resistance of Channels, Double Channels, Tees, Angles, Double Angles, and I-sections is calculated as described previously.

Lateral-torsional buckling is not considered for Tubular, Box, or Solid sections. For General or Section Designer sections, the lateral-torsional buckling resistance is taken as the design elastic moment resistance.

Chapter 7

Design for Shear Force

This chapter provides a detailed description of the design algorithm for the “Eurocode 3-2005” steel frame design when designing for shear forces. The following topics are covered:

- calculation of shear area (EC3 6.2.6(3))
- design for shear (EC3 6.2.6)
- design for shear buckling (EC3 6.2.6(6))

7.1 Shear Area

The shear area, A_v , for various section shapes is taken from the definition given in the code (EC3 6.2.6(3)).

7.2 Shear Check

The shear check at each output station shall satisfy:

$$\frac{V_{Ed}}{V_{c,Rd}} \leq 1.0 \quad (\text{EC3 6.2.6(1)})$$

where the design shear resistance $V_{c,Rd}$ is taken as:

$$V_{c,Rd} = V_{pl,Rd} = \frac{A_v (f_y / \sqrt{3})}{\gamma_{M0}} \quad (\text{EC3 6.2.6(2)})$$

For combined shear force and torsional moment, the plastic shear resistance is reduced from $V_{pl,Rd}$ to $V_{pl,T,Rd}$ accounting for the torsional effects. The shear check at each output station shall satisfy:

$$\frac{V_{Ed}}{V_{pl,T,Rd}} \leq 1.0, \quad (\text{EC3 6.2.7(9)})$$

where $V_{pl,T,Rd}$ is taken as follows:

$$V_{pl,T,Rd} = \sqrt{\left[1 - \frac{\tau_{t,Ed}}{1.25 (f_y / \sqrt{3}) / \gamma_{M0}} \right]} V_{pl,Rd} \quad (\text{I-Shapes}) \quad (\text{EC3 6.2.7(9)})$$

$$V_{pl,T,Rd} = \sqrt{\left[1 - \frac{\tau_{t,Ed}}{(f_y / \sqrt{3}) / \gamma_{M0}} \right]} V_{pl,Rd} \quad (\text{Hollow Shapes}) \quad (\text{EC3 6.2.7(9)})$$

The reduction factor $\rho_T = V_{pl,T,Rd} / V_{pl,Rd}$ is given as follows:

$$\rho_T = \frac{V_{pl,T,Rd}}{V_{pl,Rd}} = \begin{cases} \sqrt{\left[1 - \frac{\tau_{t,Ed}}{1.25 (f_y / \sqrt{3}) / \gamma_{M0}} \right]}, & \text{for I-shapes,} \\ \sqrt{\left[1 - \frac{\tau_{t,Ed}}{(f_y / \sqrt{3}) / \gamma_{M0}} \right]}, & \text{for Boxes and Pipes,} \end{cases}$$

where $\tau_{t,Ed}$ is the St Venant torsion.

7.3 Shear Buckling Check

For webs of I-sections, Boxes, Channels, Double Channels, Tees, and Double Angles without intermediate stiffeners, shear buckling is checked if:

$$\frac{h_w}{t_w} > 72 \frac{\varepsilon}{\eta} \quad (\text{EC3 6.2.6(6)})$$

where, ε is taken as:

$$\varepsilon = \sqrt{\frac{235}{f_y}} \text{ with } f_y \text{ in N/mm}^2 \quad (\text{EC3-1-5 5.1(2), EC3 Table 5.2})$$

The shear area factor, η is taken as:

$$\eta = 1.20 \text{ [NDP] for } f_y \leq 460 \text{ N/mm}^2, \text{ and} \quad (\text{EC3-1-5 5.1(2)})$$

$$\eta = 1.0 \text{ otherwise} \quad (\text{EC3-1-5 5.1(2)})$$

However for the UK, the *NDP* η is taken as 1.

$$\eta = 1.0 \text{ for UK NDP}$$

The design shear resistance $V_{c,Rd}$ is taken as:

$$V_{c,Rd} = V_{b,Rd} = V_{bw,Rd} + V_{bf,Rd} \leq \frac{\eta f_{yw} h_w t}{\sqrt{3} \gamma_{MI}} \quad (\text{EC3-1-5 5.2(1)})$$

where, $V_{bw,Rd}$ is the contribution from the web, taken as:

$$V_{bw,Rd} = \frac{\chi_w f_{yw} h_w t}{\sqrt{3} \gamma_{MI}} \quad (\text{EC3-1-5 5.2(1)})$$

It is assumed that transverse stiffeners exist only at supports and therefore the slenderness parameter, $\bar{\lambda}_w$ is taken as:

$$\bar{\lambda}_w = \frac{h_w}{86.4 t \varepsilon} \quad (\text{EC3-1-5 5.3(3)})$$

The transverse stiffeners at the supports are assumed to create only a non-rigid end post, leading to the shear contribution factor being taken as:

$$\chi_w = \begin{cases} \eta & \text{if } \bar{\lambda}_w < 0.83/\eta \\ 0.83/\eta & \text{if } \bar{\lambda}_w \geq 0.83/\eta \end{cases} \quad (\text{EC3-1-5 Table 5.1})$$

The contribution from the flanges, $V_{bf,Rd}$, is conservatively ignored.

$$V_{bf,Rd} = 0$$

Chapter 8 Design for Torsion

This chapter provides a detailed description of the design algorithm for the “Eurocode 3-2005” steel frame design when designing for torsion. The following topics are covered:

- analysis of torsion related stresses (SCI Publication 385)
- design for shear in presence of torsion (EC3 6.2.7)
- design for combined actions (EC3 6.2.1(7), 6.2.9.1(6), 6.2.9.3(2), Annex A of BS EN 1993-6)

8.1 Analysis of Torsion Stresses

In doing torsional stress check the book “Design of Steel Beams in Torsion in Accordance with Eurocodes and UK National Annexes”, the SCI Publication P385, is taken as the guide (Hughes, Iles, and Malik, 2011). Please consult the book for the details.

The torsion check is limited to the following open section: doubly-symmetric I-shapes and to the following closed sections: box and pipe shapes. I-shapes with single symmetric sections are not checked for torsion.

The elastic verification using the yield criterion given in EC3 6.2.1(5) is not used as this criterion is conservative. This criterion ignores the plastic stress redistribution.

8.2 Shear Check in Presence of Torsion

In presence or absence of torsion, the program always performs the regular shear check as described in section 7.2. For combined shear force and torsional moment, the plastic shear resistance is reduced from $V_{pl,Rd}$ to $V_{pl,T,Rd}$ accounting for the torsional effects. The shear check at each output station shall satisfy:

$$\frac{V_{Ed}}{V_{pl,T,Rd}} \leq 1.0, \quad (\text{EC3 6.2.7(9)})$$

where $V_{pl,T,Rd}$ is taken as follows:

$$V_{pl,T,Rd} = \sqrt{\left[1 - \frac{\tau_{t,Ed}}{1.25 \left(f_y / \sqrt{3} \right) / \gamma_{M0}} \right]} V_{pl,Rd} \quad (\text{I-Shapes}) \quad (\text{EC3 6.2.7(9)})$$

$$V_{pl,T,Rd} = \sqrt{\left[1 - \frac{\tau_{t,Ed}}{\left(f_y / \sqrt{3} \right) / \gamma_{M0}} \right]} V_{pl,Rd} \quad (\text{Hollow Shapes}) \quad (\text{EC3 6.2.7(9)})$$

The reduction factor $\rho_T = V_{pl,T,Rd} / V_{pl,Rd}$ is given as follows:

$$\rho_T = \frac{V_{pl,T,Rd}}{V_{pl,Rd}} = \begin{cases} \sqrt{\left[1 - \frac{\tau_{t,Ed}}{1.25 \left(f_y / \sqrt{3} \right) / \gamma_{M0}} \right]}, & \text{for I-shapes,} \\ \sqrt{\left[1 - \frac{\tau_{t,Ed}}{\left(f_y / \sqrt{3} \right) / \gamma_{M0}} \right]}, & \text{for Boxes and Pipes,} \end{cases}$$

where $\tau_{t,Ed}$ is the St Venant torsion.

8.3 Design for Combined Actions

In absence of torsion, the combined actions axial force and bending moments or axial force, shear forces, and bending moments are evaluated according to the code clauses. The details have been summarized in Chapter 8.

In presence of torsion, the total torsional moment T_{Ed} is split into a St Venant torsion $T_{i,Ed}$ and a warping torsion, $T_{w,Ed}$. The warping moment, $M_{w,Ed}$ contributes to the bending moment in the flanges. This affects the interaction checks. It also increases the minor axis bending moment by a small amount, $M_{z,T,Ed}$. The interaction equations are modified to accommodate the warping moment, $M_{w,Ed}$ and additional minor axis bending moment, $M_{z,T,Ed}$. The following equations are modified: Eq. 6.2 of section EC3 6.2.1(7), Eq. 6.41 of section EC3 6.2.9.1(6), Eq. 6.44 of section EC3 6.2.9.3(2). One additional interaction equation is checked which is given in Annex A of BS EN 1993-6. The details have been given in Chapter 8.

Chapter 9

Design for Combined Forces

This chapter provides a detailed description of the design algorithm for the Eurocode 3:2005 steel frame design, with respect to designing for combined forces. The following topics are covered:

- Design for cross-section resistance:
 - design for bending and axial force (EC3 6.2.9)
 - design for bending, shear, and axial force (EC3 6.2.10)
 - design for shear (EC3 6.2.6)
- Design for stability of members
 - prismatic members in bending and axial compression (EC3 6.3.3)
 - prismatic members in bending and axial tension (EC3 6.3.3)

For I, Box, and Pipe sections, if there is torsion present in the member and if the user indicated in the preferences that torsion needs to be considered in the design check, the interaction equations are modified to accommodate St Venant torsion $T_{t,Ed}$, warping torsion $T_{w,Ed}$, associated extra minor axis bending $M_{z,T,Ed}$, and the warping moment $M_{w,Ed}$. All those modifications are described in the following sections as needed.

9.1 Design for Cross-Section Resistance

9.1.1 Bending, Axial Force, and Shear Check

The combined effect of axial force and bending moments is checked in the same way whether the axial force is a tensile force or a compression force. There are minor exceptions that are noted in the relevant sections.

9.1.1.1 Class 1 and 2 Cross-Sections

For I and Rectangular Hollow sections, the combined axial force and bending is checked by taking the following summation of the utilization ratios for each force component as follows:

$$\left[\frac{M_{y,Ed}}{M_{N,y,Rd}} \right]^{\alpha} + \left[\frac{M_{z,Ed}}{M_{N,z,Rd}} \right]^{\beta} \leq 1 \quad (\text{EC3 6.2.9.1(6)})$$

α and β are taken as follows:

- I-sections

$$\alpha = 2 \quad (\text{EC3 6.2.9.1(6)})$$

$$\beta = 5n \geq 1 \quad (\text{EC3 6.2.9.1(6)})$$

- Rectangular Hollow sections

$$\alpha = \beta = \frac{1.66}{1 - 1.13n^2} \leq 6, \text{ where} \quad (\text{EC3 6.2.9.1(6)})$$

$$n = \frac{N_{Ed}}{N_{pl,Rd}} \quad (\text{EC3 6.2.9.1(6)})$$

$M_{N,y,Rd}$ and $M_{N,z,Rd}$ are computed as follows:

- I-sections

$M_{N,y,Rd}$ and $M_{N,z,Rd}$ for I-sections are calculated as follows:

$$M_{N,y,Rd} = M_{pl,y,Rd} \left(\frac{1-n}{1-0.5a} \right) \quad (\text{EC3 6.2.9.1(5)})$$

$$M_{N,z,Rd} = \begin{cases} M_{pl,z,Rd}, & \text{for } n \leq a, \\ M_{pl,z,Rd} \left[1 - \left(\frac{n-a}{1-a} \right)^2 \right], & \text{for } n > a \end{cases} \quad (\text{EC3 6.2.9.1(5)})$$

where,

$$n = \frac{N_{Ed}}{N_{pl,Rd}} \quad (\text{EC3 6.2.9.1(5)})$$

$$a = \frac{A - 2b_f t_f}{A} \leq 0.5 \quad (\text{EC3 6.2.9.1(5)})$$

However, if the following two conditions are true,

$$N_{Ed} \leq 0.25 N_{pl,Rd}, \quad (\text{EC3 6.2.9.1(4)})$$

$$N_{Ed} \leq 0.5 \frac{h_w t_w f_y}{\gamma_{M0}}, \quad (\text{EC3 6.2.9.1(4)})$$

$M_{N,y,Rd}$ is taken as follows:

$$M_{N,y,Rd} = M_{pl,y,Rd} \quad (\text{EC3 6.2.9.1(4)})$$

Similarly, if the following condition is true:

$$N_{Ed} \leq \frac{h_w t_w f_y}{\gamma_{M0}} \quad (\text{EC3 6.2.9.1(4)})$$

$M_{N,z,Rd}$ is taken as follows

$$M_{N,z,Rd} = M_{pl,z,Rd} \quad (\text{EC3 6.2.9.1(4)})$$

– Hollow Rectangular sections:

$M_{N,y,Rd}$ and $M_{N,z,Rd}$ are computed as follows:

$$M_{N,y,Rd} = M_{pl,y,Rd} \left(\frac{1-n}{1-0.5a_w} \right) \leq M_{pl,y,Rd} \quad (\text{EC3 6.2.9.1(5)})$$

$$M_{N,z,Rd} = M_{pl,z,Rd} \left(\frac{1-n}{1-0.5a_f} \right) \leq M_{pl,z,Rd} \quad (\text{EC3 6.2.9.1(5)})$$

where

$$a_w = \frac{A - 2bt_f}{A} \leq 0.5 \quad (\text{EC3 6.2.9.1(5)})$$

$$a_f = \frac{A - 2ht_w}{A} \leq 0.5 \quad (\text{EC3 6.2.9.1(5)})$$

For I and Rectangular Hollow sections, if there is torsion present in the member and if the user indicated in the preferences that torsion needs to be considered in the design check, the interaction equation EC3 6.2.9.1(6) is modified to accommodate effects of torsion: associated extra minor axis bending $M_{z,T,Ed}$, and the warping moment $M_{w,Ed}$.

$$\left[\frac{M_{y,Ed}}{M_{N,y,Rd}} \right]^\alpha + \left[\frac{M_{z,Ed} + M_{z,T,Ed}}{M_{N,z,Rd}} \right]^\beta + \left[\frac{M_{w,Ed}}{M_{N,z,Rd} / 2} \right] \leq 1 \quad (\text{EC3 6.2.9.1(6)})$$

- For Channel, Double Channel, Solid Rectangular, Double Angle, Angle, General, and Section Designer sections, combined axial force and bending is conservatively checked by taking a linear summation of the utilization ratios for each force component as:

$$\frac{N_{Ed}}{N_{Rd}} + \frac{M_{y,Ed}}{M_{y,Rd}} + \frac{M_{z,Ed}}{M_{z,Rd}} \leq 1.0 \quad (\text{EC3 6.2.1(7)})$$

The design axial resistance N_{Rd} is taken as $N_{t,Rd}$ or $N_{c,Rd}$, as appropriate, as defined in Section 5.2 and 5.3 of Chapter 5 of this manual. The values of $M_{y,Rd}$ and $M_{z,Rd}$ are defined in Section 6.1 of Chapter 6 of this manual for cases with both low and high shear.

- For Circular and Pipe sections, an SRSS (Square Root of Sum of Squares)

combination is made first of the two bending components before adding the axial load component, instead of the single algebraic addition as implied by the interaction equations given by EC3 6.2.1(7). The resulting interaction equation is given by the following:

$$\frac{N_{Ed}}{N_{Rd}} + \sqrt{\left(\frac{M_{y,Ed}}{M_{y,Rd}}\right)^2 + \left(\frac{M_{z,Ed}}{M_{z,Rd}}\right)^2} \leq 1.0 \quad (\text{EC3 6.2.1(7)})$$

The philosophy behind the preceding modification is that the engineer has the freedom to choose the principal axis. The engineer can easily choose the principal axis to match with the resultant moment so that the design is always based on the uniaxial bending with axial force. In that case, the moment will be the resultant (SRSS) moment from the two components. The resultant D/C ratio calculated using the preceding equations will match the calculated D/C ratio from the pure resultant moment for the Pipe and Circular sections. The reason is that M_{Rd} for Pipe and Solid Circular sections is independent of the K and L factors.

- For Tee sections, combined axial force and bending is conservatively checked by taking a linear summation of the utilization ratios for each force component as:

$$\frac{N_{Ed}}{N_{Rd}} + \frac{M_{y,Ed}}{M_{y,Rd}} + \frac{M_{z,Ed}}{M_{z,Rd}} \leq 1.0 \quad (\text{EC3 6.2.1(7)})$$

However, for this case the maximum longitudinal stress at three extreme points of the section are added with appropriate sign. That means that at the two extreme points on the flange, all three terms are added algebraically, whereas at the tip of the web, the minor axis bending term becomes zero.

9.1.1.2 Class 3 Cross-Sections

For all shapes, with the exception noted in the following text, the combined axial force and bending is conservatively checked by taking the linear summation of the utilization ratios for each force component:

$$\frac{N_{Ed}}{N_{Rd}} + \frac{M_{y,Ed}}{M_{y,Rd}} + \frac{M_{z,Ed}}{M_{z,Rd}} \leq 1.0 \quad (\text{EC3 6.2.1(7)})$$

For Doubly Symmetric sections, the preceding equation is a representation of the code-specified equation given here:

$$\sigma_{x,Ed} \leq \frac{f_y}{\gamma_{M0}} \quad (\text{EC3 6.2.9.2(1)})$$

As an exception for Circular and Pipe sections, an SRSS (Square Root of Sum of Squares) combination is made first of the two bending components before adding the axial load component, instead of the single algebraic addition as implied by the interaction equations given by EC3 6.2.1(7). The resulting interaction equation is given by the following:

$$\frac{N_{Ed}}{N_{Rd}} + \sqrt{\left(\frac{M_{y,Ed}}{M_{y,Rd}}\right)^2 + \left(\frac{M_{z,Ed}}{M_{z,Rd}}\right)^2} \leq 1.0 \quad (\text{EC3 6.2.1(7)})$$

As an exception, for Tee sections, the terms are algebraically added for three extreme points of the section. See the previous Section of this manual for details.

For I and Rectangular Hollow sections, if there is torsion present in the member and if the user indicated in the preferences that torsion needs to be considered in the design check, the interaction equation EC3 6.2.1(7) is modified to accommodate effects of torsion: associated extra minor axis bending $M_{z,T,Ed}$, and the warping moment $M_{w,Ed}$.

$$\frac{N_{Ed}}{N_{Rd}} + \frac{M_{y,Ed}}{M_{y,Rd}} + \frac{M_{z,Ed} + M_{z,T,Ed}}{M_{z,Rd}} + \frac{M_{w,Ed}}{M_{z,Rd} / 2} \leq 1.0 \quad (\text{EC3 6.2.1(7)})$$

9.1.1.3 Class 4 Cross-Sections

For all shapes, with the exception noted in the following text, the combined axial force and bending is conservatively checked by taking linear summation of the utilization ratios for each force component:

$$\frac{N_{Ed}}{N_{Rd}} + \frac{M_{y,Ed}}{M_{y,Rd}} + \frac{M_{z,Ed}}{M_{z,Rd}} \leq 1.0 \quad (\text{EC3 6.2.1(7)})$$

For Doubly Symmetric sections, the preceding equation is a representation of the code-specified equation given here:

$$\sigma_{x,Ed} \leq \frac{f_y}{\gamma_{M0}} \quad (\text{EC3 6.2.9.3(1)})$$

As an exception, for Circular and Pipe sections, an SRSS (Square Root of Sum of Squares) combination is made first of the two bending components before adding the axial load component, instead of the single algebraic addition as implied by the interaction equations given by EC3 6.2.1(7). The resulting interaction equation is given by the following:

$$\frac{N_{Ed}}{N_{Rd}} + \sqrt{\left(\frac{M_{y,Ed}}{M_{y,Rd}}\right)^2 + \left(\frac{M_{z,Ed}}{M_{z,Rd}}\right)^2} \leq 1.0 \quad (\text{EC3 6.2.1(7)})$$

As an exception, for Tee sections, the terms are algebraically added for three extreme points of the section. See a previous Section of this manual for details.

For I and Rectangular Hollow sections, if there is torsion present in the member and if the user indicated in the preferences that torsion needs to be considered in the design check, the interaction equation EC3 6.2.1(7) is modified to accommodate effects of torsion: associated extra minor axis bending $M_{z,T,Ed}$, and the warping moment $M_{w,Ed}$.

$$\frac{N_{Ed}}{N_{Rd}} + \frac{M_{y,Ed}}{M_{y,Rd}} + \frac{M_{z,Ed} + M_{z,T,Ed}}{M_{z,Rd}} + \frac{M_{w,Ed}}{M_{z,Rd} / 2} \leq 1.0 \quad (\text{EC3 6.2.1(7)})$$

In addition, Class 4 sections are checked for the following interaction equation:

$$\frac{N_{Ed}}{A_{eff} f_y / \gamma_{M0}} + \frac{M_{y,Ed} + N_{Ed} e_{Ny}}{W_{eff,y,min} f_y / \gamma_{M0}} + \frac{M_{z,Ed} + N_{Ed} e_{Nz}}{W_{eff,z,min} f_y / \gamma_{M0}} \leq 1.0 \quad (\text{EC3 6.2.9.3(2)})$$

where,

A_{eff} is the effective area of the cross-section when subjected to uniform compression,

$W_{eff,min}$ is the effective section modulus (corresponding to the fiber with maximum elastic stress) of the cross-section when subjected only to moment about the relevant axis,

e_N is the shift of the relevant centroidal axis when the cross-section is subjected to compression only. If the section is under tensile force, e_N is set to zero, and N_{Ed} is set to zero.

As an exception, for Circular and Pipe sections, an SRSS (Square Root of Sum of Squares) combination is made first of the two bending components before adding the axial load component, instead of the single algebraic addition as implied by the interaction equations given previously (EC3 6.2.9.3(2)).

As an exception, for Tee sections, the terms are algebraically added for three extreme points of the section. See the previous Section of this manual for details.

For I and Rectangular Hollow sections, if there is torsion present in the member and if the user indicated in the preferences that torsion needs to be considered in the design check, the interaction equation EC3 6.2.9.3(2) is modified to accommodate effects of torsion: associated extra minor axis bending $M_{z,T,Ed}$, and the warping moment $M_{w,Ed}$.

$$\frac{N_{Ed}}{A_{eff} f_y / \gamma_{M0}} + \frac{M_{y,Ed} + N_{Ed} e_{Ny}}{W_{eff,y,min} f_y / \gamma_{M0}} + \frac{M_{z,Ed} + M_{z,T,Ed} + N_{Ed} e_{Nz}}{W_{eff,z,min} f_y / \gamma_{M0}} + \frac{2 \times M_{w,Ed}}{W_{eff,z,min} f_y / \gamma_{M0}} \leq 1.0$$

(EC3 6.2.9.3(2))

9.1.2 Members Subjected to Shear Force

Similar to the normal stresses, shear capacity ratios for major and minor directions are produced as follows;

$$\frac{V_{y,Ed}}{V_{y,c,Rd}} \leq 1.0 \quad (\text{EC3 6.2.6(1)})$$

$$\frac{V_{z,Ed}}{V_{z,c,RD}} \leq 1.0 \quad (\text{EC3 6.2.6(1)})$$

9.2 Design for Buckling Resistance of Members

The combined effect of axial compression and bending with special emphasis to flexural and lateral-torsional buckling is checked using the section EC3 6.3.3(4). The combined effect of axial tension and bending is also checked using the same section, with the exception that the axial term is ignored.

The program checks these equations assuming the section is prismatic. For nonprismatic sections the same equations are used. However the cross-section properties used are based on the section being checked. The user is advised to check the appropriateness of this method.

For Class 1, 2, 3, and 4 sections, the same equations are checked. However, for simplicity, the versions of equations used for different classes are reported differently in this manual.

9.2.1 Class 1, 2 and 3 Sections Under Flexure and Axial Compression

The combined effect of axial compression and bending with special emphasis to flexural and lateral-torsional buckling is checked by calculating the utilization ratios based on the following two interaction equations:

$$\frac{N_{Ed}}{\chi_y N_{Rk}} + k_{yy} \frac{M_{y,Ed}}{\chi_{LT} \frac{M_{y,Rk}}{\gamma_{M1}}} + k_{yz} \frac{M_{z,Ed}}{\frac{M_{z,Rk}}{\gamma_{M1}}} \leq 1 \quad (\text{EC3 6.3.3(4)})$$

$$\frac{N_{Ed}}{\chi_z N_{Rk}} + k_{zy} \frac{M_{y,Ed}}{\chi_{LT} \frac{M_{y,Rk}}{\gamma_{M1}}} + k_{zz} \frac{M_{z,Ed}}{\frac{M_{z,Rk}}{\gamma_{M1}}} \leq 1 \quad (\text{EC3 6.3.3(4)})$$

The characteristic resistance values, N_{Rk} , $M_{y,Rk}$, and $M_{z,Rk}$ are taken as the design resistance values, N_{Rd} , $M_{y,Rd}$, and $M_{z,Rd}$, but omitting the γ_{M0} factor (EC3 Table 6.7, 6.2.5(2)). The reduction factors χ_y and χ_z are defined in Section 5.4 and χ_{LT} in Section 6.2 of this manual.

The interaction factors, k_{yy} , k_{zz} , k_{yz} , and k_{zy} , are determined based on one of two methods that may be specified in the code. The values are determined in accordance with EC3 Annex A or EC3 Annex B for Methods 1 and 2, respectively. The method are not repeated in this manual. The method for determining the interaction factors can be changed in the design preferences.

As an exception, for Circular and Pipe sections, an SRSS (Square Root of Sum of Squares) combination is made first of the two bending components before addition of the axial load component instead of simple algebraic addition as implied by the equation given previously.

9.2.2 Class 4 Sections Under Flexure and Axial Compression

The combined effect of axial compression and bending with special emphasis on flexural and lateral-torsional buckling is checked by calculating the utilization ratios based on the following interaction equations:

$$\frac{N_{Ed}}{\chi_y N_{Rk}} + k_{yy} \frac{M_{y,Ed} + N_{Ed} e_{Ny}}{\chi_{LT} \frac{M_{y,Rk}}{\gamma_{M1}}} + k_{yz} \frac{M_{z,Ed} + N_{Ed} e_{Nz}}{\frac{M_{z,Rk}}{\gamma_{M1}}} \leq 1 \quad (\text{EC3 6.3.3(4)})$$

$$\frac{N_{Ed}}{\chi_z N_{Rk}} + k_{zy} \frac{M_{y,Ed} + N_{Ed} e_{Ny}}{\chi_{LT} \frac{M_{y,Rk}}{\gamma_{M1}}} + k_{zz} \frac{M_{z,Ed} + N_{Ed} e_{Nz}}{\frac{M_{z,Rk}}{\gamma_{M1}}} \leq 1 \quad (\text{EC3 6.3.3(4)})$$

The characteristic resistance values, N_{Rk} , $M_{y,Rk}$, and $M_{z,Rk}$, the reduction factors χ_y , χ_z and χ_{LT} , the interaction factors k_{yy} , k_{zz} , k_{yz} , and k_{zy} are described in Section 8.2.1 of this manual (EC3 Table 6.7, 6.2.5(2), 6.3.1.2(1), 6.3.2.2(1), 6.3.3(5), Table A.1, Table B.1).

The shifts of the relevant centroidal axis when a Class 4 section is subjected to uniform compression, e_{Ny} and e_{Nz} , are described in Section 8.1.1.3 of this manual (EC3 6.3.3(4), 6.2.9.3(2.)).

As an exception, for Circular and Pipe sections, an SRSS (Square Root of Sum of Squares) combination is made first of the two bending components before addition of the axial load component instead of simple algebraic addition as implied by the equation given previously.

9.2.3 Class 1, 2, and 3 Sections Under Flexure and Axial Tension

The combined effect of axial tension and bending with special emphasis to flexural and lateral-torsional buckling is checked by calculating the utilization ratios based on the following two interaction equations:

$$k_{yy} \frac{M_{y,Ed}}{\chi_{LT} \frac{M_{y,Rk}}{\gamma_{M1}}} + k_{yz} \frac{M_{z,Ed}}{\frac{M_{z,Rk}}{\gamma_{M1}}} \leq 1 \quad (\text{EC3 6.3.3(4)})$$

$$k_{zy} \frac{M_{y,Ed}}{\chi_{LT} \frac{M_{y,Rk}}{\gamma_{M1}}} + k_{zz} \frac{M_{z,Ed}}{\frac{M_{z,Rk}}{\gamma_{M1}}} \leq 1 \quad (\text{EC3 6.3.3(4)})$$

The characteristic resistance values, N_{Rk} , $M_{y,Rk}$, and $M_{z,Rk}$, are taken as the design resistance values, N_{Rd} , $M_{y,Rd}$, and $M_{z,Rd}$, but omitting the γ_{M0} factor (EC3 Table 6.7, 6.2.5(2)). The reduction factor χ_{LT} is described in Section 6.2 of this manual.

The interaction factors, k_{yy} , k_{zz} , k_{yz} , and k_{zy} , are determined based on one of two methods that may be specified in the code. The values are determined in accordance with EC3 Annex A or EC3 Annex B for Methods 1 and 2, respectively. The method are not repeated in this manual. The method for determining the interaction factors can be changed in the design preferences.

As an exception, for Circular and Pipe sections, an SRSS (Square Root of Sum of Squares) combination is made first of the two bending components before

addition of the axial load component instead of simple algebraic addition as implied by the equation given previously.

9.2.4 Class 4 Sections Under Flexure and Axial Tension

The combined effect of axial tension and bending with special emphasis on flexural and lateral-torsional buckling is checked by calculating the utilization ratios based on the following interaction equations:

$$k_{yy} \frac{M_{y,Ed} + N_{Ed}e_{Ny}}{\chi_{LT} \frac{M_{y,Rk}}{\gamma_{M1}}} + k_{yz} \frac{M_{z,Ed} + N_{Ed}e_{Nz}}{\frac{M_{z,Rk}}{\gamma_{M1}}} \leq 1 \quad (\text{EC3 6.3.3(4)})$$

$$k_{zy} \frac{M_{y,Ed} + N_{Ed}e_{Ny}}{\chi_{LT} \frac{M_{y,Rk}}{\gamma_{M1}}} + k_{zz} \frac{M_{z,Ed} + N_{Ed}e_{Nz}}{\frac{M_{z,Rk}}{\gamma_{M1}}} \leq 1 \quad (\text{EC3 6.3.3(4)})$$

The characteristic resistance values, N_{Rk} , $M_{y,Rk}$, and $M_{z,Rk}$, the reduction factor χ_{LT} , the interaction factors k_{yy} , k_{zz} , k_{yz} , and k_{zy} are described in Section 8.2.1 of this manual (EC3 Table 6.7, 6.2.5(2), 6.3.1.2(1), 6.3.2.2(1), 6.3.3(5), Table A.1, Table B.1).

The shifts of the relevant centroidal axis when a Class 4 section is subjected to uniform tension, e_{Ny} and e_{Nz} , and are described in Section 8.1.1.3 of this manual (EC3 6.3.3(4), 6.2.9.3(2.)). For this case e_{Ny} and e_{Nz} are taken as zero.

As an exception, for Circular and Pipe sections, an SRSS (Square Root of Sum of Squares) combination is made first of the two bending components before addition of the axial load component instead of simple algebraic addition as implied by the equation given previously.

9.2.5 Sections of Any Class Under Flexure and Torsion

For I and Rectangular Hollow sections, if there is torsion present in the member and if the user indicated in the preferences that torsion needs to be considered in the design check, the combined effect of bending and torsion with or without the presence of any axial force with special emphasis on

flexural and lateral-torsional buckling is checked by calculating the utilization ratios based on the following interaction equations:

$$\frac{M_{y,Ed}}{\chi_{LT} \frac{M_{y,Rk}}{\gamma_{M1}}} + C_{mz} \frac{M_{z,Ed} + M_{z,T,Ed}}{\frac{M_{z,Rk}}{\gamma_{M1}}} + k_w k_{zw} k_\alpha \frac{M_{w,Ed}}{2 \times \gamma_{M1}} \leq 1 \text{ (EN 1993-6 Annex A)}$$

where,

C_{mz} is the equivalent uniform moment factor for bending about z -axis according to EC3 Table B.3 (For a simply supported beam with a parabolic moment diagram due to uniformly distributed loading $C_{mz} = 0.95$; for a triangular bending moment diagram due to single point load $C_{mz} = 0.9$),

$M_{w,Ed}$ is the warping moment caused by warping restraint and the torsion

$$k_w = 0.7 - 0.2 \frac{M_{w,Ed}}{M_{z,Rk} / \gamma_{M1}},$$

$$k_{zw} = 1 - \frac{M_{z,Ed}}{M_{z,Rk}}, \text{ and}$$

$$k_\alpha = \frac{1}{1 - \frac{M_{y,Rk}}{M_{cr}}}.$$

Chapter 10

Special Seismic Provisions

This chapter provides a detailed description of the algorithms related to seismic provisions in the design/check of structures in accordance with the “Eurocode 8: Design of structures for earthquake resistance, Part 1: General rules, seismic actions and rules for buildings, December 2004” [EN 1998-1:2004]. The program code option “Eurocode 3-2005” covers these provisions. The implementation covers load combinations from “Eurocode 3-2005,” which is described in the *Section 4.3 Design Load Combination* in Chapter 4. The loading based on “Eurocode 8-2005” has been described in a separate document entitled “CSI Lateral Load Manual” [Eurocode 8-2004; CSI 2009].

For referring to pertinent sections of the corresponding code, a unique prefix is assigned for each code.

- Reference to the Eurocode 3:2005 code is identified with the prefix "**EC3**."
- Reference to the Eurocode 8:2004 code is identified with the prefix "**EC8**."

10.1 Design Preferences

The steel frame design Preferences are basic assignments that apply to all of the steel frame members. Table A.1 lists the steel frame design Preferences.

The following steel frame design Preferences are relevant to the special seismic provisions.

- Framing Type
- Behavior Factor, q
- System overstrength factor, Ω
- Ignore Seismic Code?
- Ignore Special Seismic Load?
- Is Doubler Plate Plug Welded?

10.2 Overwrites

The steel frame design Overwrites are basic assignments that apply only to those elements to which they are assigned. Appendix B identifies the steel frame design Overwrites. The following steel frame design overwrites are relevant to the special seismic provisions.

- Frame Type
- Material overstrength factor, γ_{ov}
- System overstrength factor, Ω

10.3 Supported Framing Types

The code recognizes the types of framing systems identified in the table on the following page (EC8 6.3.1). The program has implemented specifications for all of the types of framing systems listed.

By default in the program, the frame type is taken as Ductility Class High Moment-Resisting Frame (DCH MRF). However, the default frame type can be changed in the Preferences for all frames or in the Overwrites on a member-by-member basis. If a frame type Preference is revised in an existing model, the revised frame type does not apply to frames that have already been assigned a frame type through the Overwrites; the revised Preference applies only to new

frame members added to the model after the Preference change and to the old frame members that were not assigned a frame type though the Overwrites.

Framing Type	References
DCH MRF (Ductility Class High Moment-Resisting Frame)	EC8 6.6
DCM MRF (Ductility Class Medium Moment-Resisting Frame)	EC8 6.6
DCL MRF (Ductility Class Low Moment-Resisting Frame)	EC8 6.6
DCH CBF (Ductility Class High Concentrically Braced Frame)	EC8 6.7
DCM CBF (Ductility Class Medium Concentrically Braced Frame)	EC8 6.7
DCL CBF (Ductility Class Low Concentrically Braced Frame)	EC8 6.7
DCH EBF (Ductility Class High Eccentrically Braced Frame)	EC8 6.8
DCM EBF (Ductility Class Medium Eccentrically Braced Frame)	EC8 6.8
DCL EBF (Ductility Class Low Eccentrically Braced Frame)	EC8 6.8
Inverted Pendulum Structure	EC8 6.9
Secondary	EC8 4.2.2

10.4 Member Design

This section describes the special requirements for designing a member. The section has been divided into subsections for each framing type.

The behavior factor q accounts for the energy dissipation capacity of the structure. For regular structural systems, the behavior factor q should be taken with the upper limits referenced to the values given in EC8, Table 6.2.

Table 9.1 Upper Limits of Behavior Factor

Structural Type	Ductility Class		Figure 6.1(a) to (c) α_u/α_1 for DCH
	DCM	DCH	
Moment resisting frames	4	$5\alpha_u/\alpha_1$	1.1-1.3
Frames with concentric bracing			
- Diagonal Bracing	4	4	–
- V-bracing	2	2.5	
Frame with eccentric bracings	4	$5\alpha_u/\alpha_1$	1.2
Inverted Pendulum	2	$2\alpha_u/\alpha_1$	1.1

10.4.1 Ductility Class High Moment-Resisting Frames (DCH MRF)

The following additional requirements are checked or reported (EC8 6.6).

NOTE: The geometrical constraints and material requirements given in EC8 Section 6.2 should be independently checked by the user because the program does not perform those checks.

10.4.1.1 Beams

- All beams are required to be Class 1 sections (EC8 6.5.3(2), Table 6.3).
- To ensure that the full plastic moment of resistance and rotation capacity are not decreased by compression or shear forces, the following conditions are checked (EC8 6.6.2(2)):

$$\frac{M_{Ed}}{M_{pl,Rd}} \leq 1.0 \quad (\text{EC8 Eq. 6.2})$$

$$\frac{N_{Ed}}{N_{pl,Rd}} \leq 0.15 \quad (\text{EC8 Eq. 6.3})$$

$$\frac{V_{Ed}}{V_{pl,Rd}} \leq 0.5 \quad (\text{EC8 Eq. 6.4})$$

where,

$$V_{Ed} = V_{Ed,G} + V_{Ed,M} \quad (\text{EC8 Eq. 6.5})$$

N_{Ed} is the factored design axial force,

M_{Ed} is the factored design bending moment,

V_{Ed} is the factored design shear,

$V_{Ed,G}$ is the design shear force due to non-seismic actions,

$V_{Ed,M}$ is the design shear force due to plastic moments $M_{pl,Rd,A}$ and $M_{pl,Rd,B}$ with opposite signs at the end of section A and B of the beam i.e.,

$$V_{Ed,M} = (M_{pl,Rd,A} + M_{pl,Rd,B}) / L$$

$N_{pl,Rd}, M_{pl,Rd}, V_{pl,Rd}$ are the design resistance factors in accordance with section 6.2.3.1 of EN 1993-1-1-2004.

10.4.1.2 Columns

- All columns are required to be Class 1 sections (EC8 6.5.3(2), Table 6.3).
- The columns are checked by considering the most unfavorable combination of axial force and bending moments. In the design checks, N_{Ed}, M_{Ed}, V_{Ed} are computed as follows (EC8 6.6.3(1)P):

$$N_{Ed} = N_{Ed,G} + 1.1\gamma_{ov}\Omega N_{Ed,E} \quad (\text{EC8 Eq. 6.6})$$

$$M_{Ed} = M_{Ed,G} + 1.1\gamma_{ov}\Omega M_{Ed,E} \quad (\text{EC8 Eq. 6.6})$$

$$V_{Ed} = V_{Ed,G} + 1.1\gamma_{ov}\Omega V_{Ed,E} \quad (\text{EC8 Eq. 6.6})$$

where,

$N_{Ed,G}, M_{Ed,G}, V_{Ed,G}$ are the compression force, bending moment and shear force in the column, respectively, due to the nonseismic actions included in the combination of actions for the seismic design situation.

$N_{Ed,E}, M_{Ed,E}, V_{Ed,E}$ are the compression force, bending moment, and shear force in the column, respectively, due to design seismic action.

γ_{ov} is the material overstrength factor.

Ω is the minimum value of $\Omega_i = M_{pl,Rd,i} / M_{Ed,i}$ of all lateral beams;
 $M_{Ed,i}$ is the design bending moment in beam i in the seismic combination
and $M_{pl,Rd,i}$ is the corresponding plastic moment.

NOTE: Ω is not calculated automatically by the program. Rather, its value can be overwritten by the user through design Preference and Overwrites.

- The column shear force V_{Ed} resulting from analysis should satisfy the following condition (EC8 6.6.3(4)):

$$\frac{V_{Ed}}{V_{pl,Rd}} \leq 0.5 \quad (\text{EC8 Eq. 6.7})$$

10.4.2 Ductility Class Medium Moment-Resisting Frames (DCM MRF)

The additional requirements for Ductility Class Medium Moment-Resisting Frames (DCM MRF) are the same as the requirements for Ductility Class High Moment-Resisting Frames (DCH MRF) with the exception of the followings (EC8 6.6).

10.4.2.1 Beams

- All beams and column are required to be Class 1 or Class 2 sections for $2 < q \leq 4$ (EC8 6.5.3(2), Table 6.3) and Class 1, 2 or Class 3 sections for $1.5 < q \leq 2$ (EC8 6.5.3(2), Table 6.3).

10.4.3 Ductility Class Low Moment-Resisting Frames (DCL MRF)

The resistance of the members and connections are evaluated in accordance with EN 1993 without any additional requirements (EC8 6.1.2(4)).

10.4.4 Ductility Class High Concentrically Braced Frames (DCH CBF)

The following additional requirements are checked or reported (EC8 6.7).

10.4.4.1 Brace

- All braces are required to be Class 1 sections (EC8 6.5.3(2), Table 6.3).
- The slenderness ratio, $\bar{\lambda}$, of X diagonal bracing members as defined in EN 1993-1-1:2004 is limited to the following (EC8 6.7.3(1)):

$$1.3 \leq \bar{\lambda} \leq 2.0. \quad (\text{EC8 6.7.3(1)})$$

where,

$$\bar{\lambda} = \sqrt{\frac{Af_y}{N_{cr}}} \quad (\text{EC3 6.3.1.3})$$

$$N_{cr} = N_{cr,TF} < N_{cr,T} \quad (\text{EC3 6.3.1.4})$$

$N_{cr,TF}$ is the elastic torsional-flexural buckling force, and

$N_{cr,T}$ is the elastic torsional buckling force

For torsional or torsional-flexural buckling the appropriate buckling curve is determined from EC3 Table 6.2 considering the one related to the z-axis.

- The slenderness ratio, $\bar{\lambda}$, of frames with diagonal bracings in which diagonals are not positioned as X diagonal bracing should be limited to (EC8 6.7.3(2)):

$$\bar{\lambda} \leq 2.0. \quad (\text{EC8 6.7.3(2)})$$

- The slenderness ratio, $\bar{\lambda}$, of frames with V bracings should be limited to (EC8 6.7.3(3)):

$$\bar{\lambda} \leq 2.0. \quad (\text{EC8 6.7.3(3)})$$

- The slenderness ratio, $\bar{\lambda}$ does not apply to structures up to two stories (EC8 6.7.3(4)):

- The yield resistance $N_{pl,Rd}$ of the gross cross-section of the diagonal should be (EC8 6.7.3(5)):

$$N_{Ed} \leq N_{pl,Rd} \quad (\text{EC8 6.7.3(5)})$$

where,

$$N_{pl,Rd} = \frac{Af_y}{\gamma_{M0}} \quad (\text{EC3 6.2.3(2)})$$

- To ensure a homogeneous dissipative behavior of the diagonals, the maximum system overstrength Ω_i defined in EC8 6.7.4(1) does not differ from the minimum value of Ω by more than 25%.

NOTE: Ω is not calculated automatically by the program. Rather, its value can be overwritten by the user through design Preference and Overwrites.

10.4.4.2 Beams and Columns

- All beams and columns are required to be Class 1 sections (EC8 6.5.3(2), Table 6.3).
- The beams and columns are checked by considering the most unfavorable combination of axial force and bending moment. In design check the M_{Ed} and V_{Ed} are taken from the factored loads. However, the axial force N_{Ed} is modified as follows (EC8 6.7.4 (1)):

$$N_{Ed} = N_{Ed,G} + 1.1\gamma_{ov}\Omega N_{Ed,E} \quad (\text{EC8 Eq. 6.12})$$

where,

$N_{Ed,G}$ is the axial force in the beam or in the column due to nonseismic actions included in the seismic load combinations,

$N_{Ed,E}$ is the axial force in the beam or in the column due to design seismic action,

γ_{ov} is the material overstrength factor,

Ω is the minimum value of $\Omega_i = N_{pl,Rd,i} / N_{Ed,i}$ over all the diagonals of the braced frame system where; $N_{pl,Rd,i}$ is the design resistance of diagonal i and $N_{Ed,i}$ is the design axial force in the same diagonal i in the seismic combination.

NOTE: Ω is not calculated automatically by the program. Rather, its value can be overwritten by the user through design Preference and Overwrites.

10.4.5 Ductility Class Medium Concentrically Braced Frames (DCM CBF)

The additional requirements for Ductility Class Medium Concentrically Braced Frames (DCM CBF) are the same as the requirements for Ductility Class High Concentrically Braced Frames (DCH CBF) with the exception of the followings (EC8 6.7).

10.4.5.1 Brace

- All braces are required to be Class 1 or Class 2 sections for $2 < q \leq 4$ (EC8 Table 6.3) and Class 1, 2 or Class 3 sections for $1.5 < q \leq 2$ (EC8 6.5.3(2), Table 6.3).

10.4.5.2 Beams and Columns

- All beams and columns are required to be Class 1 or Class 2 sections for $2 < q \leq 4$ (EC8 6.5.3(2), Table 6.3) and Class 1, 2 or Class 3 sections for $1.5 < q \leq 2$ (EC8 6.5.3(2), Table 6.3).

10.4.6 Ductility Class Low Concentrically Braced Frames (DCL CBF)

The resistance of the members and connections are evaluated in accordance with EN 1993 without any additional requirements (EC8 6.1.2(4)).

10.4.7 Ductility Class High Eccentrically Braced Frames (DCH EBF)

The following additional requirements are checked or reported (EC8 6.8).

For this framing system, the program looks for and recognizes the eccentrically braced frame configurations shown in Figure 9-1. The other case that is described in EC8 Figure 6.4 is not covered.

The following additional requirements are checked or reported for the beams, columns, and braces associated with these configurations.

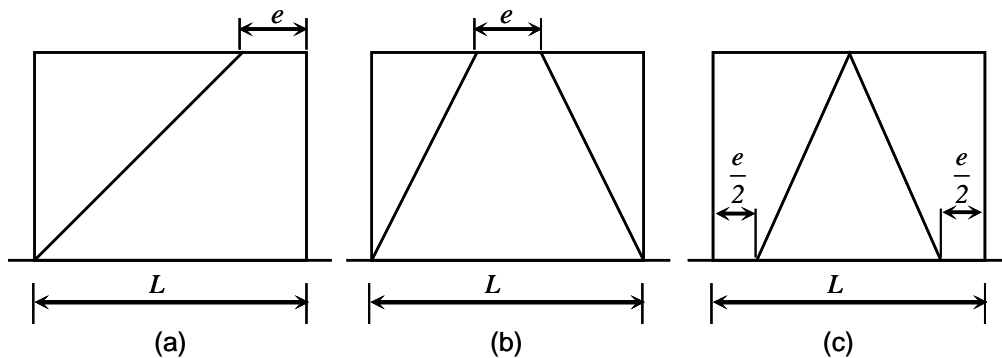

Figure 9-1. Eccentrically Braced Frame Configurations

- All beams, columns and braces are required to be Class 1 (EC8 6.5.3(2), Table 6.3).
- The link beams are classified into three categories according to the type of plastic mechanism developed (EC8 6.8.2(2)):
 - Short links (e_s), which dissipate energy by yielding essentially in shear;
 - Long links (e_l), which dissipate energy by yielding essentially in bending;
 - Intermediate links (e), which plastic mechanism involves bending and shear.
- For I-sections, the design resistance is computed as follows (EC8 6.8.2(3)):

$$M_{p,link} = f_y b t_f (d - t_f) \quad (\text{EC8 Eq. 6.13})$$

$$V_{p,link} = (f_y / \sqrt{3}) t_w (d - t_f) \quad (\text{EC8 Eq. 6.14})$$

- When $N_{Ed} / N_{pl,Rd} \leq 0.15$, the design resistance of link should satisfy both of the following criteria at both ends of link (EC8 6.8.2(4)):

$$V_{Ed} \leq V_{p,link} \quad (\text{EC8 Eq. 6.15})$$

$$M_{Ed} \leq M_{p,link} \quad (\text{EC8 Eq. 6.16})$$

where, N_{Ed} , M_{Ed} , V_{Ed} are the factored design axial forces, design bending moment and design shear, at both ends of the links.

- When $N_{Ed} / N_{pl,Rd} > 0.15$, the design resistance of link should satisfy both of the following criteria at both ends of the link (EC8 6.8.2(5)):

$$V_{Ed} \leq V_{p,link} \left[1 - (N_{Ed} / N_{pl,Rd})^2 \right]^{0.5} \quad (\text{EC8 Eq. 6.17})$$

$$M_{Ed} \leq M_{p,link} \left[1 - (N_{Ed} / N_{pl,Rd}) \right] \quad (\text{EC8 Eq. 6.18})$$

- When $N_{Ed} / N_{pl,Rd} > 0.15$, the link length (e) should not exceed the following limit (EC8 6.8.2(6)):

$$e \leq 1.6 M_{p,link} / V_{p,link} \quad \text{when } R < 0.3, \text{ or} \quad (\text{EC8 Eq. 6.19})$$

$$e \leq (1.15 - 0.5R) 1.6 M_{p,link} / V_{p,link} \quad \text{when } R \geq 0.3 \quad (\text{EC8 Eq. 6.20})$$

where,

$$R = \left[N_{Ed} t_w (d - 2t_f) \right] / (V_{Ed} A) \quad (\text{EC8 6.8.2(6)})$$

- The individual values of the ratios Ω_i defined in EC8 section 6.8.3.1 do not exceed the minimum value of Ω resulting from EC8 section 6.8.3.1 by more than 25% of the minimum value (EC8 6.8.2.(7)).

NOTE: Ω is not calculated automatically by the program. Rather, its value can be overwritten by the user through design Preference and Overwrites.

- The link length e is classified as follows. For I-sections, the categories are (EC8 6.8.2.(8)):

- Short links (e_s), $e < e_s = 1.6 M_{p,link} / V_{p,link}$ (EC8 Eq. 6.21)

- Long links (e_L), $e < e_s = 3.0 M_{p,link} / V_{p,link}$ (EC8 Eq. 6.22)

- Intermediate links (e), $e < e_s < e_L$ (EC8 Eq. 6.23)

If the check is not satisfied, the program reports an error message.

- The link beam rotation, θ , of the individual bay relative to the rest of the beam is calculated as the story drift Δ times bay length (L) divided by the total lengths of link beams (e) in the bay.

The link rotation, θ , is checked as follows (EC8 6.6.4(3)):

$$\theta = \frac{\delta L}{e} \quad (\text{EC8 Fig 6.14(a)})$$

$$\theta \leq \begin{cases} 0.08 \text{ radian, for short link where } e \leq e_s \\ 0.02 \text{ radian, for short link where } e \geq e_L \\ \text{value interpolated between 0.08 and 0.02 radian, for } e < e_s < e_L \end{cases}$$

δ is story drift

e is link length

L is beam span

- The beams and columns are checked by considering the most unfavorable combination of axial force and bending moment. In design check the M_{Ed} and V_{Ed} are taken from the factored loads. However, the axial force N_{Ed} is modified as follows (EC8 6.8.3 (1)):

$$N_{Ed} = N_{Ed,G} + 1.1\gamma_{ov}\Omega N_{Ed,E} \quad (\text{EC8 Eq. 6.30})$$

where,

$N_{Ed,G}$ is the axial force in the beam or in the column due to nonseismic actions included in the seismic load combinations,

$N_{Ed,E}$ is the axial force in the beam or in the column due to design seismic action,

γ_{ov} is the material overstrength factor,

Ω is a multiplicative factor, and the minimum of the following values:

(a) the minimum value of $\Omega_i = 1.5V_{pl,link,i}/V_{Ed,i}$ among all short links,

(b) the minimum value of $\Omega_i = 1.5M_{pl,link,i}/M_{Ed,i}$ among all intermediate and long links. $V_{Ed,i}, M_{Ed,i}$ are the design values of the shear force and of the bending moment in the link i in the seismic load combination. $V_{p,link,i}, M_{p,link,i}$ are the shear and bending plastic design resistances of link i as defined in EC8 6.8.2(3).

NOTE: Ω is not calculated automatically by the program. Rather, its value can be overwritten by the user through design Preference and Overwrites.

Note: Axial forces in the beams are included in checking the beams. The user is reminded that using a rigid diaphragm model will result in zero axial forces in the beams. The user must disconnect some of the column lines from the diaphragm to allow beams to carry axial loads. It is recommended that only one column line per eccentrically braced frame be connected to the rigid diaphragm or that a flexible diaphragm model be used.

10.4.8 Ductility Class Medium Eccentrically Braced Frames (DCM EBF)

The additional requirements for Ductility Class Medium Eccentrically Braced Frames (DCM EBF) are same as the requirements for Ductility Class High Eccentrically Braced Frames (DCH EBF) with the exception of the followings (EC8 6.8).

10.4.8.1 Brace

- All braces are required to be Class 1 or Class 2 sections for $2 < q \leq 4$ (EC8 Table 6.3) and Class 1, 2 or Class 3 sections for $1.5 < q \leq 2$ (EC8 6.5.3(2), Table 6.3).

10.4.8.2 Beams and Columns

- All beams and columns are required to be Class 1 or Class 2 sections for $2 < q \leq 4$ (EC8 6.5.3(2), Table 6.3) and Class 1, 2 or Class 3 sections for $1.5 < q \leq 2$ (EC8 6.5.3(2), Table 6.3).

10.4.9 Ductility Class Low Eccentrically Braced Frames (DCL EBF)

The resistance of the members and connections are evaluated in accordance with EN 1993 without any additional requirements (EC8 6.1.2(4)).

10.4.10 Inverted Pendulum

For this framing system, the following additional requirements are checked or reported (EC8 6.9).

- This framing system is checked to be designed using axial compression by considering the most unfavorable combination of axial force and bending moments (EC8, 6.9(1)).
- N_{Ed}, M_{Ed}, V_{Ed} are computed in accordance with EC8 section 6.6.3.
- The limit to slenderness ratio for the columns, $\bar{\lambda}$, should be limited to $\bar{\lambda} \leq 1.5$ (EC8 6.9(3)).
- The interstory drift sensitivity coefficient, θ , as defined in EC8 section 4.4.2.2 should be limited to $\theta \leq 0.2$ (EC8 6.9(4)). This clause has not been implemented in the program. The user is required to check this clause independently.

10.4.11 Secondary

The resistance of the members and connections are evaluated in accordance with EN 1993 without any additional requirements.

10.5 Design of Joint Components

In a plan view of a beam-column connection, a steel beam can frame into a column in the following ways.

- The steel beam frames in a direction parallel to the column major direction, i.e., the beam frames into the column flange.
- The steel beam frames in a direction parallel to the column minor direction, i.e., the beam frames into the column web.
- The steel beam frames in a direction that is at an angle to both of the principal axes of the column, i.e., the beam frames partially into the column web and partially into the column flange.

To achieve a proper beam-column moment connection strength, continuity plates are usually placed on the column, in line with the top and bottom flanges of the beam, to transfer the compression and tension flange forces of the beam into the column. For connection conditions described by the first bullet, where the beam frames into the flange of the column, the program investigates joint component checks based on EC3-1-8 section 6.2.6.1 to 6.2.6.4. Columns of I- or H sections connected with I-shaped beam sections only are investigated. The joint components requirements are evaluated for medium and high ductile moment frames (MRF DCM and MRF DCH) only. No check is made for braced frames.

The program evaluate the following checks.

- Check the requirement of continuity plate and determine of its area
- Check the requirement of supplementary web plate and determine of its thickness
- Check the ratio of sum of beam flexural strength to sum of column flexural strength

- Report the beam connection shear
- Report the brace connection force

10.5.1 Design of Continuity Plates

The program first evaluates the need for continuity plates. When the required strength F_{Ed} exceeds the available resistance $F_{c,wc,Rd}$, $F_{t,wc,Rd}$, or $F_{fc,Rd}$, as appropriate, a continuity plate will be required. The program checks the following limit states.

(a) Column Web in Transverse Compression

- The design resistance of an unstiffened column web subjected to transverse compression is given as follows (EC3-1-8 6.2.6.2):

$$F_{c,wc,Rd} = \frac{\omega k_{wc} b_{eff,c,wc} t_{wc} f_{y,wc}}{\gamma_{M0}} \leq \frac{\omega k_{wc} \rho b_{eff,c,wc} t_{wc} f_{y,wc}}{\gamma_{M1}} \quad (\text{EC3-1-8 Eq. 6.9})$$

where,

ω is a reduction factor to allow for the possible effects of interaction with shear in column web panel according to EC3-1-8 Table 6.3. ω is a function of β in EC8 Table 6.3. Approximate values for the transformation parameter β is also given in EC3-1-8 Table 5.4. Conservatively, program uses $\beta = 2$ (EC3-1-8 5.3(7)).

$b_{eff,c,wc}$ is the effective width of column web in compression. For a welded connection,
 $b_{eff,c,wc} = t_{fb} + 2\sqrt{2}a_b + 5(t_{fc} + s)$, where a_b, a_c and r_c are indicated in EC3-1-8 Figure 6.6.

In computing $b_{eff,c,wc}$, a_b is taken as $t_{fb}/2$ and a_c is taken as $t_{fc}/2$ in the program.

For a rolled I or H section column: $s = r_c$

For a welded I or H section column: $s = \sqrt{2}a_c$

ρ is the reduction factor for plate buckling:

$$\text{If } \bar{\lambda}_p \leq 0.72: \quad \rho = 1 \quad (\text{EC3-1-8 Eq. 6.13a})$$

$$\text{If } \bar{\lambda}_p > 0.72: \quad \rho = (\bar{\lambda}_p - 0.2) / \bar{\lambda}_p^2 \quad (\text{EC3-1-8 Eq. 6.13b})$$

$\bar{\lambda}_p$ is the plate slenderness:

$$\bar{\lambda}_p = 0.932 \sqrt{\frac{b_{eff,c,wc} d_{wc} f_{y,wc}}{Et_{wc}^2}} \quad (\text{EC3-1-8 Eq. 6.13c})$$

For a rolled I or H section column: $d_{wc} = h_c - 2(t_{fc} + r_c)$

For a welded I or H section column: $d_{wc} = h_c - 2(t_{fc} + \sqrt{2}a_c)$

k_{wc} is the reduction factor and is given in EC3-1-8 6.2.6.2(2):

Where the maximum longitudinal compressive stress $\sigma_{com, Ed}$ due to axial force and bending moment in the column exceed $0.7 f_{y,wc}$ in the web (adjacent to the root radius for a rolled section or the toe of the weld for a welded section), its effect on the design resistance of the column web in compression is reduced by k_{wc} as follows:

$$\text{when } \sigma_{com, Ed} \leq 0.7 f_{y,wc}; \quad k_{wc} = 1 \quad (\text{EC3-1-8 Eq. 6.14})$$

$$\text{when } \sigma_{com, Ed} > 0.7 f_{y,wc}; \quad k_{wc} = 1.7 - \sigma_{com, Ed} / f_{y,wc}$$

conservatively, k_{wc} is taken as 1.

(b) Column Web in Transverse Tension

- The design resistance of an unstiffened column web subjected to transverse tension is given as follows (EC3-1-8 6.2.6.3):

$$F_{t,wc,Rd} = \frac{\omega b_{eff,t,wc} t_{wc} f_{y,wc}}{\gamma_{M0}}, \quad (\text{EC3-1-8 Eq. 6.15})$$

where,

ω is a reduction factor to allow for the possible effects of interaction with shear in column web panel in accordance with EC3-1-8 Table 6.3. ω is a function of β in EC8 Table 6.3. Approximate values for the transformation parameter β is also given in EC3-1-8 Table 5.4. Conservatively, program uses $\beta = 2$ (EC3-1-8 5.3(7)).

$b_{eff,t,wc}$ is the effective width of column web in tension. For a welded connection,

$$b_{eff,t,wc} = t_{fb} + 2\sqrt{2}a_b + 5(t_{fc} + s), \text{ where } a_b, a_c \text{ and } r_c \text{ are as indicated in EC3-1-8 Figure 6.6.}$$

For a rolled I or H section column: $s = r_c$

For a welded I or H section column: $s = \sqrt{2}a_c$

(c) Column flange in transverse bending

- The design resistance of an unstiffened column flange, welded connection is given as follows (EC3-1-8 6.2.6.4.3):

$$F_{fc,Rd} = \frac{b_{eff,b,fc} t_{fb} f_{y,fb}}{\gamma_{M0}} \quad (\text{EC3-1-8 Eq. 6.20})$$

where,

$b_{eff,b,fc}$ is the effective breadth b_{eff} as defined in EC3-1-8 section 4.10(2)

where the beam flange is considered as plate.

$$b_{eff,b,fc} = t_{wc} + 2s + 7kt_{fc} \quad (\text{EC3-1-8 Eq. 4.6a})$$

$$k = \left(t_f / t_p\right) \left(f_{y,f} / f_{y,p}\right) \leq 1.0 \quad (\text{EC3-1-8 Eq. 4.6b})$$

$f_{y,f}$ is the yield strength of the flange of the I or H section,

$f_{y,p}$ is the yield strength of the plate of the I or H section.

The dimension s is obtained from the following expression:

For a rolled I or H section column: $s = r_c$ (EC3-1-8 Eq. 4.6c)

For a welded I or H section column: $s = \sqrt{2}a_c$ (EC3-1-8 Eq. 4.6d)

The continuity plate is compute the following equations:

$$A_{cp} = \max \left\{ \begin{array}{l} \frac{(F_{Ed} - F_{c,wc,Rd})}{F_{b,Rd}} \\ \frac{(F_{Ed} - F_{t,wc,Rd})}{F_{b,Rd}} \\ \frac{(F_{Ed} - F_{fc,Rd})}{F_{b,Rd}} \end{array} \right. \quad (\text{EC3-1-5 9.4.(2)})$$

Continuity plates are designed for all moment resisting frame for factored load. In this case F_{Ed} is taken as follows:

$$F_{Ed} = \frac{M_{Ed}}{(d - t_f)}$$

In addition, continuity plates are designed for DCH MRF and DCM MRF for capacity moment. In this case F_{Ed} is taken as follows:

$$F_{Ed} = 1.1\gamma_{0v} b_{fb} t_{fb} f_{yb} \quad (\text{EC8 6.5.5(3), Eq. 6.1})$$

In the preceding expressions, $F_{b,Rd}$ is the allowable design compression resistance of the equivalent column related to the beam-column joint. $F_{b,Rd}$ is taken as follows:

$$F_{b,Rd} = \frac{\chi f_y}{\gamma_{M1}} \quad (\text{EC3 6.3.1.1(3), EC3-1-5 9.4(2)})$$

The reduction factor, χ for the relevant buckling mode is taken as:

$$\chi = \frac{1}{\Phi + \sqrt{\Phi^2 - \lambda^2}} \leq 1.0 \quad (\text{EC3 6.3.1.2(1)})$$

where the factor, Φ and the non-dimensional slenderness, $\bar{\lambda}$ are taken as:

$$\Phi = 0.5 \left[1 + \alpha(\bar{\lambda} - 0.2) + \bar{\lambda}^2 \right] \quad (\text{EC3 6.3.1.2(1)})$$

$$\bar{\lambda} = \sqrt{\frac{Af_y}{N_{cr}}} = \frac{L_{cr}}{i} \frac{1}{\lambda_1} \quad (\text{EC3 6.3.1.3(1)})$$

$$\lambda_1 = \pi \sqrt{\frac{E}{f_y}} \quad (\text{EC3 6.3.1.3(1)})$$

$$\alpha = 0.49 \text{ (using buckling curve c)} \quad (\text{EC3-1-5 9.4(2)})$$

$$L_{cr} = Kl \quad (\text{EC3-1-5 9.4(2)})$$

$$K = 0.75 \quad (\text{EC3-1-5 9.4(2)})$$

$$l = d_c - 2t_{fc} \quad (\text{EC3-1-5 9.4(2)})$$

$$i = \min\{i_{33}, i_{22}\} \text{ of the equivalent column} \quad (\text{EC3-1-5 9.4(2)})$$

The member properties of the equivalent column are taken as follows:

- The cross-section is comprised of two stiffeners and a strip of the web having a width of $25t_{wc}$ at the interior stiffener and $12t_{wc}$ at the ends of the column (borrowed from AISC J10.8).
- The effective length is taken as $0.75h$, i.e., $K = 0.75$ and $L = h = d_c - 2t_{fc}$ (EC3-1-5 9.4(2)).
- $\frac{L_{cr}}{i}$ is calculated based on the equivalent cross-section and equivalent length stated here.

In addition to satisfying the preceding limit states, it is made sure that the equivalent section, consisting of the stiffeners and part of the web plate, is able to resist the compressive concentrated force (EC3-9-5 9.4(2)). This is similar to a column capacity check. For this condition, the program calculates the required continuity plate area as follows:

$$A_{cp} = \frac{P_{bf}}{F_{b,Rd}} - 25t_{wc}^2, \quad \text{if not at top story} \quad (\text{EC3-1-5 9.4(2)})$$

$$A_{cp} = \frac{P_{bf}}{F_{b,Rd}} - 12t_{wc}^2, \quad \text{if at top story} \quad (\text{EC3-1-5 9.4(2)})$$

An iterative process is involved as A_{cp} , r , and F_{cr} are interdependent. If A_{cp} is needed, iteration starts with the minimum thickness and minimum width of the continuity plate. A maximum of three iterations is performed.

If $A_{cp} \leq 0$, no continuity plates are required. If continuity plates are required, they must satisfy a minimum area specification defined as follows:

- The minimum thickness of the stiffeners is taken as follows:

$$t_{cp}^{\min} = 0.5t_{fb} \quad (\text{borrowed from AISC J10.8})$$

- The minimum width of the continuity plate on each side plus 1/2 the thickness of the column web shall not be less than 1/3 of the beam flange width, or

$$b_{cp}^{\min} = 2 \left(\frac{b_{fp}}{3} - \frac{t_{wc}}{2} \right), \quad (\text{borrowed from AISC J10.8})$$

so that the minimum area is given by

$$A_{cp}^{\min} = t_{cp}^{\min} b_{cp}^{\min}. \quad (\text{borrowed from AISC J10.8})$$

Therefore, the continuity plate area provided by the program is zero or the greater of A_{cp} and A_{cp}^{\min} .

In the preceding equations,

A_{cp} = Required continuity plate area

f_y = Yield stress of the column and continuity plate material

h = Clear distance between flanges of column less fillets for rolled shapes

F_{Ed} = Beam flange force

$F_{c,wc,Rd}$ = Resistance of column web

t_{fb} = Beam flange thickness

t_{fc} = Column flange thickness

t_{wc} = Column web thickness

10.5.2 Design of Supplementary Web Plates

One aspect of the design of a steel framing system is an evaluation of the shear forces that exist in the region of the beam-column intersection known as the panel zone.

Shear stresses seldom control the design of a beam or column member. However, in a Moment-Resisting frame, the shear stress in the beam-column joint can be critical, especially in framing systems when the column is subjected to major direction bending and the joint shear forces are resisted by the web of the column. In minor direction bending, the joint shear is carried by the column flanges, in which case the shear stresses are seldom critical, and this condition is therefore not investigated by the program.

Shear stresses in the panel zone, due to major direction bending in the column, may require additional plates to be welded onto the column web, depending on the loading and the geometry of the steel beams that frame into the column, either along the column major direction or at an angle so that the beams have components along the column major direction. The program investigates such situations and reports the thickness of any required supplementary web plates. Only columns with I-Shapes are investigated for supplementary web plate requirements. Also supplementary web plate requirements are evaluated for moment frames only (MRF DCH and MRF DCM).

The program calculates the required thickness of supplementary web plates using the following algorithms. The shear force in the panel zone is given by:

$$V_{wp,Ed} = \frac{(M_{b1,Ed} \cos \theta_{b1} - M_{b2,Ed} \cos \theta_{b2})}{z} - \frac{(V_{c1,Ed} - V_{c2,Ed})}{2} \quad (\text{EC3-1-8, Eq. 5.3})$$

For DCH MRF and DCM MRF, $M_{b1,Ed}$ and $M_{b2,Ed}$ are determined from capacity design principal. In these cases, $M_{b,Ed}$ is taken as

$$M_{b,Ed} = \gamma_{ov} W_{pl} f_y \quad (\text{EC8 6.1.3(2)})$$

The available resistance of the web panel zone for the limit state of shear yielding resistance is determined as $V_{wp,Rd}$ as appropriate (EC8 6.1.3(2)). Assuming that the effect of panel zone deformation on frame stability has not been considered in analysis, the shear resistance, $V_{wp,Rd}$, is determined as follows (EC3-1-8 6.2.6.1):

When detailed in accordance with the following conditions:

- i. When the supplementary web plate is Plug welded.
- ii. The joint panel zone is designed to satisfy the width-to-thickness limit of EC3-1-8 Clause 6.2.6.1(1) i.e., $d/t_w = 69\varepsilon$.
- iii. The steel grade of the supplementary web plate should be equal to of that of the column.
- iv. The width b_s should be such that the supplementary web plate extends at least to the toe of the root radius or of the weld.
- v. The length l_s should be such that the supplementary web plate extends throughout the effective width of the web in tension and compression. See Figure 6.5 of EC 3-1-8.
- vi. The thickness t_s of the supplementary web plate should not be less than the column web thickness t_{wc} .
- vii. The welds between the supplementary web plate and profile should be designed to resist the applied design forces.
- viii. The width b_s of a supplementary web plate should be less than $40\varepsilon t_s$.

- ix. For a single-sided joint, or a double-sided joint in which the beam depths are similar, the design plastic shear resistance $V_{wp,Rd}$ of an unstiffened column web panel, subjected to design force $V_{wp,Ed}$, is obtained using the following:

$$V_{wp,Rd} = \frac{0.9 f_{y,wc} A_{vc}}{\sqrt{3} \gamma_{M0}} \quad (\text{EC3-1-8 Eq. 6.7})$$

By using $V_{wp,Rd} = V_{wp,Ed}$, the required column panel zone thickness t_p is found as follows.

$$t_p = \frac{V_{wp,Ed} \sqrt{3} \gamma_{M0}}{0.9 f_{y,wc} h}$$

The extra thickness or the required thickness of the supplementary web plate, t_s , is given as follows:

$$t_s = t_p - t_{wc}$$

- If the required supplementary web plate $t_s > t_w$, a failure condition is declared (EC3-1-8 6.2.6.1(6)),
- If the required supplementary web plate is not plug welded,
 - if $h_{wc}/t_{wc} > 69\varepsilon$, a failure condition is declared.
 - if $b_s/t_s > 40\varepsilon$, then web supplementary plate thickness is set as $t_s = b_s/40\varepsilon$,
- If the required supplementary web plate is plug welded, and if $h_{wc}/(t_{wc} + t_s) > 69\varepsilon$, a failure condition is declared. The web supplementary plate thickness is set as $t_s = h_{wc}/69\varepsilon - t_{wc}$.

where,

$f_{y,wc}$ = Column and supplementary web plate yield stress

z = lever arm, $z = h - t_{fb}$; see EC3-1-8 section 6.2.7

- t_p = Required column panel zone thickness
- t_{fb} = Flange thickness of beam
- t_s = Required supplementary web plate thickness
- t_{fc} = Column flange thickness
- t_{wc} = Column web thickness
- $V_{wp,Rd}$ = Required panel zone shear capacity
- $V_{c1,Ed}$ = Column shear in column below
- $V_{c2,Ed}$ = Column shear in column above
- h = Overall depth of beam connecting to column
- θ_b = Angle between beam and column major direction
- h_c = Overall depth of column
- $M_{b1,Ed}$ = Factored beam moment from corresponding loading combination from beam 1 based on either factored forces or based on capacity moment of beam 1
- $M_{b2,Ed}$ = Factored beam moment from corresponding loading combination from beam 2 based on either factored forces or based on capacity moment of beam 2
- $V_{wp,Rd}$ = Shear resistance of the panel

The largest calculated value of t_s , calculated for any of the load combinations based on the factored beam moments and factored column axial loads, is reported.

The supplementary web plate and the column web should satisfy the slenderness criteria as stated in the preceding text. If the t_{wc} cannot satisfy the criteria, then a failure condition is declared. If t_s does not satisfy

fy this criterion, then its value is increased to meet the criteria. If the check is not satisfied, it is noted in the output.

10.5.3 Weak Beam/Strong Column Measure

For Moment Resisting Frames Ductility Class High (MRF DCH) and Moment Resisting Frames Ductility Class Medium (MRF DCM) frames with seismic design only, the code requires that the sum of the column flexure strengths at a joint should be more than the sum of the beam flexure strengths (EC8 4.4.2.3). The column flexure strength should reflect the presence of axial force in the column. The beam flexural strength should reflect the potential increase in capacity for strain hardening. To facilitate the review of the strong column/weak beam criterion, the program will report a beam-column plastic moment capacity ratio for every joint in the structure.

For the major direction of any column (top end), the beam-to-column-strength ratio is obtained as

$$R_{\text{maj}} = \frac{1.3 \sum_{n=1}^{n_b} M_{Rbn} \cos \theta_n}{M_{pl,RdA} + M_{pl,RdB}} \quad (\text{EC8 4.4.2.3, Eq. 4.29})$$

For the minor direction of any column, the beam-to-column-strength ratio is obtained as

$$R_{\text{min}} = \frac{1.3 \sum_{n=1}^{n_b} M_{Rbn} \sin \theta_n}{M_{pl,RdA} + M_{pl,RdB}} \quad (\text{EC8 4.4.2.3, Eq. 4.29})$$

where,

R_{maj} = Plastic moment capacity ratios, in the major directions of the column

R_{min} = Plastic moment capacity ratios, in the minor directions of the column

M_{Rbn} = Plastic moment capacity of n -th beam connecting to column

θ_n = Angle between the n -th beam and the column major direction

$M_{pl,RdA}$ = Major and minor plastic moment capacities, reduced for axial force effects, of column above story level

$M_{pl,RdB}$ = Major and minor plastic moment capacities, reduced for axial force effects, of column below story level

n_b = Number of beams connecting to the column

The plastic moment capacities of the columns are reduced for axial force effects and are taken as

$$M_{N,Rd} = M_{pl,Rd} \left[1 - \left(\frac{N_{Ed}}{N_{pl,Rd}} \right)^2 \right] \quad (\text{EC3 Eq. 6.32})$$

The plastic moment capacities of the beams are amplified for potential increase in capacity for strain hardening as

$$M_{pl,Rd} = \gamma_{ov} W_{plb} F_{yb} \quad (\text{EC8 6.1.3(2)})$$

where,

W_{plb} = Plastic modulus of beam

W_{pl} = Plastic modulus of column

F_{yb} = Yield stress of beam material

F_{yc} = Yield stress of column material

N_{Ed} = Axial compression force in the column for the given load combination

For the preceding calculations, the section of the column above is taken to be the same as the section of the column below, assuming that the column splice will be located some distance above the story level.

10.5.4 Evaluation of Beam Connection Shears

For each steel beam in the structure, the program will report the maximum major shears at each end of the beam for the design of the beam shear connections. The beam connection shears reported are the maxima of the factored shears obtained from the loading combinations.

For special seismic design, the beam connection shears are not taken less than the following special values for different types of framing. The special seismic requirements additionally checked by the program are dependent on the type of framing used.

- For DCH MRF and DCM MRF, the beam connection shear is taken as the maximum of those from regular load combinations and those required for the development of the full plastic moment capacity of the beam. The connection shear for the development of the full plastic moment capacity of the beam is as follows:

$$V_{Ed} = V_{Ed,G} + V_{Ed,M} \quad (\text{EC8 6.6.4(1), 6.6.2(2)})$$

$$V_{Ed,M} = \frac{CM_{Ed,M}}{L}, \quad (\text{EC8 6.6.2(2)})$$

where,

V = Shear force corresponding to END I or END J of beam

C = 0 if beam ends are pinned, or for cantilever beam
= 1 if one end of the beam is pinned
= 2 if no ends of the beam are pinned

$M_{Ed,M}$ = Plastic moment capacity of beam = $1.1\gamma_{ov}W_{pl}f_y$ (EC8 6.6.4(1), 6.5.5(3), Eq. 6.1)

L = Clear length of the beam

$V_{ED,G}$ = Absolute maximum of the calculated beam shears at the corresponding beam ends from the factored gravity load only

- For DCL MRF, the beam connection shear is taken as the maximum shear from the load combinations.
- For DCH CBF and DCM CBF, the beam connection shear is taken as the maximum of those from regular load combinations and from the capacity design principal.
- For DCL CBF, the beam connection shear is taken as the maximum shear from the load combinations.
- For DCH EBF and DCM EBF, the beam connection shear is taken as the minimum of the two values: (a) maximum shear from the load combinations and (b) maximum shear based on the link beam shear capacity.

The maximum beam connection shear based on the link beam shear capacity is taken as the beam connection shear that can be developed when the first link beam yields in shear. The load factor for the seismic component of the load in the combination is calculated to achieve forces related to yielding of the link beam.

If the beam-to-column connection is modeled with a pin by releasing the beam end in the program, it automatically affects the beam connection shear.

- For DCL EBF, the beam connection shear is taken as the maximum shear from the load combinations.

10.5.5 Evaluation of Brace Connection Forces

For each steel brace in the structure, the program reports the maximum axial force at each end of the brace for the design of the brace-to-beam connections. The brace connection forces reported are the maxima of the factored brace axial forces obtained from the loading combinations.

For seismic design, the brace connection forces are not taken less than the following special values for different types of framing. The seismic requirements additionally checked by the program are dependent on the type of framing used.

Brace axial forces for seismic designs are evaluated for braced frames only (DCH CBF, DCM CBF, DCH EBF and DCM EBF). No special checks are performed for moment frames (MRF DCH and MRF DCM).

- For DCH CBF and DCM CBF, the bracing connection axial force is taken as (6.5.5(3), 6.7.3(7)):

$$R_d = 1.1\gamma_{ov}R_{fy} \quad (\text{EC8 6.7.7(7), 6.5.5(3), Eq. 6.1})$$

where,

R_d is the axial resistance of the connection in accordance with EC3;

R_{fy} is the plastic resistance of the connected dissipative member based on the design Af_y of the material as defined in EC3.

γ_{ov} is the material overstrength factor.

- For DCL CBF, the bracing connection force is taken from the factored force with load combination factors.
- For DCH EBF and DCM EBF, the required axial strength of the diagonal brace connection at both ends of the brace is taken as follows:

$$E_{d,G} + 1.1\gamma_{ov}\Omega E_{d,E} \quad (\text{EC8 6.8.4(1), Eq. 6.31})$$

where,

$E_{d,G}$ is the action effect in the connection due to the non-seismic actions included in the combination of actions for the seismic design situation;

$E_{d,E}$ is the action effect in the connection due to the design seismic action;

γ_{ov} is the material overstrength factor

Ω is the system overstrength factor computed in accordance with 6.8.3(1) for the link.

NOTE: Ω is not calculated automatically by the program. Rather, its value can be overwritten by the user through design Overwrites.

- For DCL EBF, the bracing connection force is taken from the load combination.

The maximum connection force from the load combinations is determined for all of the regular load combinations.

Appendix A Design Preferences

The steel frame design preferences are general assignments that are applied to all of the steel frame members. The design preferences should be reviewed and any changes from the default values made prior to performing a design.

Table A-1: Steel Frame Design Preferences

Item	Possible Values	Default Value	Description
Design Code	Design codes available in the current version	AISC360-10/ IBC 2006	The selected design code. Subsequent design is based on this selected code.
Multi-Response Case Design	Envelopes, Step-by-Step, Last Step, Envelopes, All, Step-by-Step - All	Envelopes	Select to indicate how results for multivalued cases (Time history, Nonlinear static or Multi-step static) are considered in the design. - Envelope - considers enveloping values for Time History and Multi-step static and last step values for Nonlinear static. Step-by-Step - considers step by step values for Time History and Multi-step static and last step values for Nonlinear static. Last Step - considers last values for Time History, Multi-step static and Nonlinear static. Envelope - All - considers enveloping values for Time History, Multi-step static and Nonlinear static. Step-by-Step - All - considers step by step values for Time History, Multi-step static and Nonlinear static. Step-by-Step and Step-by-Step - All default to the corresponding Envelope if more then one multivalued case is present in the combo.

Table A-1: Steel Frame Design Preferences

Item	Possible Values	Default Value	Description
Framing Type	Type LD MRF, Type MD MRF, Type D MRF, Type LD CBF(V), Type LD CBF(TC), Type LD CBF(TO), Type LD CBF(OT), Type MD CBF(V), Type MD CBF(TC), Type MD CBF(TO), Type MD CBF(OT), EBF, Cantilever, Column, Conventional MF, Conventional BF	Type LD MRF	This item is used for ductility considerations in the design.
Spectral Acceleration Ratio, $I_e * F_a * S_a(0.2)$	> 0	0.35	This is $S_a(T=0.2\text{sec})$ multiplied by I_e and F_a . It can assume different values in two orthogonal directions. The value specified here is solely used for design. The program uses the same value for all directions. See CSA S16-14 section 27.1.2, NBCC section 4.1.8.2, Table 4.1.8.9, Table 4.1.8.5, and Table 4.1.8.4B for details.
Ductility Related Modification Factor, R_d	> 0	5	Overstrength-related force modification factor reflecting the capability of a structure to dissipate energy through inelastic behavior. This is a function of Seismic Force Resisting System. It can assume different values in two orthogonal directions. The program uses the same value for all directions. The value specified here is solely used for design. See CSA S16-14 section 27.1.2, NBCC sections 4.1.8.2 and 4.1.8.9, and NBCC Table 4.1.8.9 for details
Overstrength Related Modification Factor	> 0	1.5	This accounts for the dependable portion of reserve strength in a structure. This is a function of Seismic Force Resisting System. It can assume different values in two orthogonal directions. The program uses the same value for all directions. The value specified here is solely used for design. See CSA S16-14 section 27.1.2, NBCC sections 4.1.8.2 and 4.1.8.9, and NBCC Table 4.1.8.9 for details.
Phi (Bending)	≤ 1.0	0.9	Strength reduction factor.
Phi (Compression)	≤ 1.0	0.9	Strength reduction factor.
Phi (Tension)	≤ 1.0	0.9	Strength reduction factor.
Phi (Shear)	≤ 1.0	0.9	Strength reduction factor.
Slender Section Modification	Modify Geometry, Modify F_y	Modify Geometry	Select if the Class 4 sections should be handled by modifying the geometry or by modifying f_y .

Table A-1: Steel Frame Design Preferences

Item	Possible Values	Default Value	Description
Ignore Seismic Code?	Yes, No	No	Toggle to consider (No) or not consider (Yes) the seismic part of the code in design.
Ignore Special Seismic Load?	Yes, No	No	Toggle to consider (No) or not consider (Yes) special seismic load combinations in design.
Is Doubler Plate Plug Welded?	Yes, No	Yes	Toggle to indicate if the doubler-plate is plug welded (Yes), or it is not plug welded (No).
Consider Deflection?	Yes, No	Yes	Toggle to consider the deflection limit (Yes) or to not consider the deflection limit (No).
DL Limit, L/	≥ 0	120	Deflection limit for dead load. Inputting 120 means that the limit is L/120. Inputting zero means no check will be made of this item.
Super DL+LL Limit, L/	≥ 0	120	Deflection limit for superimposed dead plus live load. Inputting 120 means that the limit is L/120. Inputting zero means no check will be made of this item.
Live Load Limit, L/	≥ 0	360	Deflection limit for superimposed live load. Inputting 360 means that the limit is L/360. Inputting zero means no check will be made of this item.
Total Limit, L/	≥ 0	240	Deflection limit for total load. Inputting 240 means that the limit is L/240. Inputting zero means no check will be made of this item.
Total-Camber Limit, L/	≥ 0	240	Limit for net deflection. Camber is subtracted from the total load deflection to get net deflection. Inputting 240 means that the limit is L/240. Inputting zero means no check will be made of this item.
Pattern Live Load Factor	≤ 1.0	0.75	The live load factor for automatic generation of load combinations involving pattern live loads and dead loads.
Demand/Capacity Ratio Limit	≤ 1.0	0.95	The demand/capacity ratio limit to be used for acceptability. D/C ratios that are less than or equal to this value are considered acceptable.

Appendix B Design Overwrites

The steel frame design overwrites are assignments that are applied on a member-by-member basis. The design overwrites should be reviewed and any changes from the default values made prior to performing a design. The following table lists the design overwrites that are specific to using Eurocode 3-1:2005; the overwrites that are generic to all codes are not included in this table.

Table B-1: Design Overwrites

Overwrite	Description
Framing Type	This is "DCH-MRF", "DCM-MRF", "DCL-MRF", "DCH-CBF", "DCM-CBF", "DCL-CBF", "DCH-EBF", "DCM-EBF", "DCL-EBF", "InvPendulum", "Secondary", or "NonSeismic". This item is used for ductility considerations in the design.
Section Class	Section class to be used. This can be "Class 1," "Class 2," "Class 3," or "Class 4." It determines the capacity of the sections and the interaction equations to be used. If not overwritten, it is calculated based on Table 5.2 of the EN 1993-1-1:2005 code.
Column Buckling Curve (y-y)	Column buckling curve to be used for flexural buckling about major axis. This can be "a0," "a," "b," "c," or "d." It determines the imperfection factors for buckling curve. If not overwritten, it is taken from Table 6.2 of the EN 1993-1-1:2005 code.
Column Buckling Curve (z-z)	Column buckling curve to be used for flexural buckling about minor axis. This can be "a0," "a," "b," "c," or "d." It determines the imperfection factors for buckling curve. If not overwritten, it is taken from Table 6.2 of the EN 1993-1-1:2005 code.

Table B-1: Design Overwrites

Overwrite	Description
Buckling Curve for LTB	Buckling curve to be used for lateral-torsional buckling. This can be "a0," "a," "b," "c," or "d." The program gives one extra option "a0" following flexural buckling mode. It determines the imperfection factors for buckling curve. If not overwritten, it is taken from the Table 6.4 of the EN 1993-1-1:2005 code.
System Overstrength Factor, Omega	This is called the System Overstrength Factor. Omega factor is related to seismic factored member force and member capacity. It can assume different values in two orthogonal directions. The Omega value specified here is solely used for design. The program uses the same value for all directions. See EC8 sections 6.6.3(1), 6.7.4(1), 6.8.3(1), and 6.8.4(1) for details. Specifying 0 means the value is program determined. Program determined value means it is taken from the preferences.
Is Rolled Section?	Toggle to consider whether the design section has to be considered as "Rolled" or "Welded". It affects the selection of buckling curve from Table Tables 6.2 and 6.4 of the code, "EN 1993-1-1:2005."
Material Overstrength Factor, Gamma_ov	The ratio of the expected yield strength to the minimum specified yield strength. This ratio is used in capacity based design for special seismic cases. See EC8 sections 6.1.3(2), 6.2(3), 6.5.5(3), 6.6.3(1), 6.7.4(1), 6.8.3(1), and 6.8.4(1) for details. Specifying 0 means the value is program determined.
Net Area to Total Area Ratio	The ratio of the net area at the end joint to gross cross-sectional area of the section. This ratio affects the design of axial tension members. Specifying zero means the value is the program default, which is 1.
Live Load Reduction Factor	The reducible live load is multiplied by this factor to obtain the reduced live load for the frame object. Specifying zero means the value is program determined.
Unbraced Length Ratio (Major)	Unbraced length factor for buckling about the frame object major axis; specified as a fraction of the frame object length. This factor times the frame object length gives the unbraced length for the object. Specifying zero means the value is program determined.
Unbraced Length Ratio (Minor)	Unbraced length factor for buckling about the frame object minor axis; specified as a fraction of the frame object length. This factor times the frame object length gives the unbraced length for the object. Specifying zero means the value is program determined.
Unbraced Length Ratio (LTB)	Unbraced length factor for lateral-torsional buckling for the frame object; specified as a fraction of the frame object length. This factor times the frame object length gives the unbraced length for the object. Specifying zero means the value is program determined.

Table B-1: Design Overwrites

Overwrite	Description
Effective Length Factor Braced (K1 Major)	Effective length factor for buckling about the frame object major axis; specified as a fraction of the frame object length. This factor times the frame object length gives the effective length for the object. Specifying zero means the value is program determined. For beam design, this factor is always taken as 1, regardless of any other value specified in the Overwrites. This factor is used for the calculation of k factors.
Effective Length Factor Braced (K1 Minor)	Effective length factor for buckling about the frame object minor axis; specified as a fraction of the frame object length. This factor times the frame object length gives the effective length for the object. Specifying zero means the value is program determined. For beam design, this factor is always taken as 1, regardless of any other value specified in the Overwrites. This factor is used for calculation of the k factors.
Effective Length Factor Sway (K2 Major)	Effective length factor for buckling about the frame object major axis assuming that the frame is braced at the joints against sideway; specified as a fraction of the frame object length. This factor times the frame object length gives the effective length for the object. Specifying zero means the value is program determined. The factor is used for axial compression capacity.
Effective Length Factor Sway (K2 Minor)	Effective length factor for buckling about the frame object minor axis assuming that the frame is braced at the joints against sideway; specified as a fraction of the frame object length. This factor times the frame object length gives the effective length for the object. Specifying zero means the value is program determined. The factor is used for axial compression capacity.
Effective Length Factor Sway (LTB)	Effective length factor for lateral-torsional buckling; specified as a fraction of the frame object length. This factor times the frame object length gives the effective length for the object. Specifying zero means the value is program determined. For beam design, this factor is taken as 1 by default. The values should be set by the user.
Bending Coefficient (C1)	Unitless factor; C_1 is used in determining the interaction ratio. Inputting zero means the value is program determined.
D/C Ratio Limit	The demand/capacity ratio limit to be used for acceptability. D/C ratios that are less than or equal to this value are considered acceptable. Specifying zero means the value is program determined.
Moment coefficient (k_{yy} Major)	Moment coefficient for major axis bending determined by Method 1 or Method 2 from Annex A or B of the code.

Table B-1: Design Overwrites

Overwrite	Description
Moment coefficient (k_{zz} Minor)	Moment coefficient for minor axis bending determined by Method 1 or Method 2 from Annex A or B of the code.
Moment coefficient (k_{zy})	Moment coefficient determined by Method 1 or Method 2 from Annex A or B of the code.
Moment coefficient (k_{yz})	Moment coefficient determined by Method 1 or Method 2 from Annex A or B of the code.

Appendix C Nationally Determined Parameters (NDPs)

This appendix provides a listing of the Nationally Determined Parameters (NDPs) used by default for the various country implementations. Several of these parameters can be modified either through the design preferences or the design overwrites.

C.1 CEN Default

Table C.1 lists the default NDPs for the CEN Default implementation.

Table C.1: CEN Default NDP Values

Code Clause	NDP	Default Value
EC3 6.1(1)	γ_{M0}	1.00
EC3 6.1(1)	γ_{M1}	1.00
EC3 6.1(1)	γ_{M2}	1.25
EC0 6.4.3.2	Combinations equation	Eq. 6.10
EC3 6.3.3(5)	Interaction factors method	Method 2
EC0 Table A1.2(B)	$\gamma_{Gj,sup}$	1.35
EC0 Table A1.2(B)	$\gamma_{Gj,inf}$	1.00
EC0 Table A1.2(B)	$\gamma_{Q,1}$	1.5

Table C.1: CEN Default NDP Values

Code Clause	NDP	Default Value
EC0 Table A1.1	$\psi_{0,i}$	0.7 (live load) 0.6 (wind load)
EC0 Table A1.2(B)	ξ	0.85
EC0 Table A1.1	$\psi_{2,i}$	0.3 (assumed office/residential)
EC3 6.3.2.2(2)	α_{LT}	0.21 for buckling curve a 0.34 for buckling curve b 0.49 for buckling curve c 0.76 for buckling curve d
EC3 6.3.2.3(1)	β	0.75
EC3-1-5 5.1(2)	η	1.20 for $f_y \leq 460 \text{ N/mm}^2$ 1.00 for $f_y > 460 \text{ N/mm}^2$

C.2 Bulgaria

Table C.2 lists the NDP values for the Bulgarian National Annex, where they differ from the CEN Default values listed in Table C.1.

Table C.2: Bulgaria NDP Values

Code Clause	NDP	Default Value
EC3 6.1(1)	γ_{M0}	1.05
EC3 6.1(1)	γ_{M1}	1.05

C.3 Slovenia

The NDP values for the Slovenian National Annex, are the same as the CEN Default values listed in Table C.1.

C.4 United Kingdom

Table C.3 lists the NDP values for the United Kingdom National Annex, where they differ from the CEN Default values listed in Table C.1.

Table C.3: United Kingdom NDP Values

Code Clause	NDP	Default Value
EC3 6.1(1)	γ_{M2}	1.10
EC0 Table A1.1	$\psi_{0,i}$	0.7 (live load) 0.5 (wind load)
EC0 Table A1.2(B)	ξ	0.925
EC3-1-5 5.1(2)	η	1.00

C.5 Norway

Table C.4 lists the NDP values for the Norwegian National Annex, where they differ from the CEN Default values listed in Table C.1.

Table C.4: Norway NDP Values

Code Clause	NDP	Default Value
EC3 6.1(1)	γ_{M0}	1.05
EC3 6.1(1)	γ_{M1}	1.05
EC0 Table A1.2(B)	ξ	0.89

C.6 Sweden

Table C.5 lists the NDP values for the Sweden National Annex, where they differ from the CEN Default values listed in Table C.1.

Table C.5: Sweden NDP Values

Code Clause	NDP	Default Value
EC0 6.4.3.2	Combinations equation	Eq. 6.10a/b
EC3 6.3.3(5)	Interaction factors method	Method 1
EC0 Table A1.2(B)	γ_d	Class 1 = 0.83, Class 2 = 0.91, Class 3 = 1.0
EC0 Table A1.2(B)	$\gamma_{Gj,sup}$	1.35* γ_d
EC0 Table A1.2(B)	$\gamma_{Q,I}$	1.5* γ_d
EC0 Table A1.1	$\psi_{0,i}$	0.7 (live load) 0.3 (wind load)
EC0 Table A1.2(B)	ξ	0.89

C.7 Finland

Table C.6 lists the NDP values for the Finland National Annex, where they differ from the CEN Default values listed in Table C.1.

Table C.6: Finland NDP Values

Code Clause	NDP	Default Value
EC0 6.4.3.2	Combinations equation	Eq. 6.10a/b
EC0 Table A1.2(B)	K_{FI}	Class 1 = 0.9, Class 2 = 1.0, Class 3 = 1.1
EC0 Table A1.2(B)	$\gamma_{Gj,sup}$	1.35* K_{FI}
EC0 Table A1.2(B)	$\gamma_{Gj,inf}$	0.9
EC0 Table A1.2(B)	$\gamma_{Q,I}$	1.5* K_{FI}

C.8 Denmark

Table C.7 lists the NDP values for the Denmark National Annex, where they differ from the CEN Default values listed in Table C.1.

Table C.7: Denmark NDP Values

Code Clause	NDP	Default Value
EC3 6.1(1)	γ_{M0}	1.10
EC3 6.1(1)	γ_{M1}	1.20
EC3 6.1(1)	γ_{M2}	1.35
EC0 6.4.3.2	Combinations equation	Eq. 6.10a/b
EC0 Table A1.2(B)	K_{FI}	Class 1 = 0.9, Class 2 = 1.0, Class 3 = 1.1
EC0 Table A1.2(B)	$\gamma_{Gj,sup}$	1.2 / 1.0 (Eq. 6.10a / 6.10b)* K_{FI}
EC0 Table A1.2(B)	$\gamma_{Gj,inf}$	1.0 / 0.9 (Eq. 6.10a / 6.10b)
EC0 Table A1.2(B)	$\gamma_{Q,1}$	1.5* K_{FI}
EC0 Table A1.1	$\psi_{0,i}$	0.6 (live load) 0.6 (wind load)
EC0 Table A1.2(B)	ξ	1.0
EC0 Table A1.1	$\psi_{2,i}$	0.2 (assumed office/residential)

C.9 Portugal

Table C.8 lists the NDP values for the Portugal National Annex, where they differ from the CEN Default values listed in Table C.1.

Table C.8: Portugal NDP Values

Code Clause	NDP	Default Value
EC3 6.3.2.3(1)	$\bar{\lambda}_{LT,0}$	0.2
EC3 6.3.2.3(1)	β	1.0

C.10 Germany

Table C.9 lists the NDP values for the German National Annex, where they differ from the CEN Default values listed in Table C.1.

Table C.9: Germany NDP Values

Code Clause	NDP	Default Value
EC3 6.1(1)	γ_{M1}	1.1

C.11 Singapore

Table C.10 lists the NDP values for the Singapore National Annex, where they differ from the CEN Default values listed in Table C.1.

Table C.10: Singapore NDP Values

Code Clause	NDP	Default Value
EC3 6.1(1)	γ_{M2}	1.1
EC3 Annex B	$\bar{\lambda}_Z$ for non-doubly symmetric sections	$\max(\bar{\lambda}, \bar{\lambda}_T)$
EC3 Table B.1 and B.2	Where sections are not I, H, or hollow sections, k_{yy} , k_{yz} , k_{zy} , and k_{zz} for Class 1 and 2 sections are calculated as if the section is Class 3.	

C.12 Poland

Table C.11 lists the NDP values for the Poland National Annex, where they differ from the CEN Default values listed in Table C.1.

Table C.11: Poland NDP Values

Code Clause	NDP	Default Value
EC3 6.1(1)	γ_{M2}	1.1

References

- EN 1990:2002. Eurocode 0 — Basis of Structural Design (includes Amendment A1:2005), European Committee for Standardization, rue de Stassart, 36, B-1050 Brussels. 2002.
- EN 1993-1-1:2005. Eurocode 3: Design of Steel Structures – Part 1-1: General Rules and Rules for Buildings, European Committee for Standardization, rue de Stassart, 36, B-1050 Brussels. May 2005.
- EN 1993-1-3:2006. Design of Steel Structures – Part 1-3: General Rules and Supplementary Rules for Cold-Formed Members and Sheeting, European Committee for Standardization, rue de Stassart, 36, B-1050 Brussels.
- EN 1993-1-5:2006. Eurocode 3 — Design of Steel Structures – Part 1-5: Plated Structural Elements, European Committee for Standardization, rue de Stassart, 36, B-1050 Brussels. October 2006.
- EN 1993-1-6:2007. Eurocode 3 — Design of Steel Structures – Part 1-6: Strength and Stability of Shell Structures, European Committee for Standardization, rue de Stassart, 36, B-1050 Brussels.
- EN 1993-1-8:2005. Eurocode 3 — Design of Steel Structures – Part 1-8: Design of Joints, European Committee for Standardization, rue de Stassart, 36, B-1050 Brussels. September 2006
- EN 1993-1-12:2007. Eurocode 3 — Design of Steel Structures – Part 1-12: Design of Joints, European Committee for Standardization, rue de Stassart, 36, B-1050 Brussels.

- ENV 1993-1-1:1992. Eurocode 3. — Design of Steel Structures. — Part 1-1: General Rules and Rules for Buildings. European Committee for Standardization, rue de Stassart, 36, B-1050 Brussels.
- EN 1998-1:2004. Eurocode 8 — Design of structures for earthquake resistance – Part 1: General rules, seismic actions and rules for buildings (EN 1998-1:2004), European Committee for Standardization, rue de Stassart, 36, B-1050 Brussels.
- Hughes, A. F., Iles, D. C., and Malik, A. S. Design of Steel Beams in Torsion in Accordance with Eurocodes and UK National Annexes, SCI Publication P385, SCI, Silwood Park, Ascot, Berkshire, SL5 7QN, UK, ISBN 13:978-1-85942-200-7, 2011.
- UK NA EC0:2002. UK National Annex for Eurocode 0 – Basis of Structural Design. British Standards Institute. December 2004.
- UK NA EC3-1-1:2005. UK National Annex to Eurocode 3: Design of Steel Structures – Part 1-1: General Rules and Rules for Buildings. British Standards Institute. December 2008.
- UK NA EC3-1-5:2005. UK National Annex to Eurocode 3: Design of Steel Structures – Part 1-5: Plated Structural Elements. British Standards Institute. May 2008.